

FITTINGS

VHP FITTINGS
PAGE 6

CONED FITTINGS
PAGE 10

MICRO/NANO
PAGE 17

**FLAT-BOTTOM
FITTINGS**
PAGE 21



How to Order

Direct from IDEX Health & Science

For North America orders:

Tel: +1 800 426 0191 / +1 360 679 2528

Fax: +1 800 359 3460 / +1 360 679 3830

E-mail: CustomerService.hs@idexcorp.com

For Europe orders:

Tel: +49 (0) 1801 808 800

Fax: +49 (0) 9377 1388

E-mail: CustomerService.hsEurope@idexcorp.com

For Asia orders:

E-mail: CustomerService.hsAsia@idexcorp.com

NORTH ASIA

Tel: +86 10 6566 9090 / +86 21 5241 5599

Fax: +86 10 6567 5152 / +86 21 5241 8338

SOUTHEAST ASIA AND OCEANIA

Tel: +65 6684 7307

Fax: +65 6795 8070

SOUTH ASIA

Tel: +91 22 66 78 55 50

Fax: +91 22 66 78 00 55

JAPAN

Tel: +81 48 240 5750

Fax: +81 48 259 0715

For Online orders:

Web: www.idex-hs.com

Please include the following information with your order: Purchase Order Number, Contact Name, Shipping and Billing Address, Telephone Number, Product Number(s) and Quantity(ies). If you are a Purchasing Agent, please include the name of the person for whom the products are ordered.

For your information, our U.S. Federal Taxpayer Identification number is 01-0736657; European Taxpayer Identification number is DE 146581180.

Order Processing/Shipping

Orders process within one business day and ship within two business days. Requests for earlier shipments can be made — please contact IDEX Health & Science for more details.

All shipments are FCA unless otherwise noted. Shipping charges will be prepaid and added to the invoice. Or, if requested, we will charge your carrier account number.

Terms

Terms of payment are net 30 days. **Credit cards are accepted for orders placed directly with our U.S. site. No international credit card payment is possible.** Customers are responsible for C.O.D. charges if they elect this payment method. Terms and prices are subject to change without notice. Visit www.idex-hs.com for complete Terms & Conditions.

Return of Materials

Returns must be authorized in advance. Please contact us within 30 days of purchase for your Returns Material Authorization (RMA) Number. A restocking fee may apply.



Customer Number:

Direct from our Global Distribution Network

The IDEX Health & Science brands represented in this catalog (Ismatec®, Isolation Technologies™, Rheodyne®, Systec®, and Upchurch Scientific®) have established relationships with a large, global network of Distributors, many of whom can offer the product support and assistance that we cannot, including:

- ▶ Carrying local inventory of commonly-ordered items
- ▶ Understanding YOUR working environment and requirements
- ▶ Providing technical application assistance
- ▶ Answering questions regarding new and existing products
- ▶ Complete availability during your time zone business hours
- ▶ Personal visits as required
- ▶ Access to complementary product lines to provide a "one-stop shopping" experience

We have come to rely on our authorized Distributors to provide value-added service to end-users of our products. So, while we are happy to take your order directly, we encourage you to contact your local Distributor — we feel confident it will be a positive experience!

How to Find A Local Distributor

For a complete distributor listing please visit www.idex-hs.com/distributors or email:

US: CustomerService.hs@idexcorp.com

Europe: CustomerService.hsEurope@idexcorp.com

Asia: CustomerService.hsAsia@idexcorp.com

Our customer service team will help you contact a distributor in your area.

Return of Materials

Product purchased through a Distributor must be returned directly to that Distributor. Please contact them for Return Material Authorization procedures.

The products in this catalog are intended for use with analytical, biotechnology and diagnostic equipment and accessories. THE MANUFACTURERS OF THE PRODUCTS IN THIS CATALOG SHALL HAVE NO LIABILITY WHATSOEVER DUE TO ANY MISUSE OF THEIR PRODUCTS. Of course, the safe use of our products depends on our customers, since it is you who select and control the protective gear and safety procedures used, as well as the pressures, temperatures, solvents, samples, ventilation, and other variables. Product and material performance ratings are provided as guides only. Individual field tests should be performed by customers to determine safe operating parameters given your particular procedures and use.

IDEX Health & Science facilities are certified ISO 9001. Some facilities are also certified ISO 13485:2003.



Visit us online!
www.idex-hs.com

Fittings Chapter

In this catalog, we've taken a new approach to presenting our extensive line of fittings. In one comprehensive chapter, you will find fittings for several applications — very high pressure (> 15,000 psi/1,034 bar), high pressure (> 1,000 psi/69 bar), and low pressure (< 1,000 psi/69 bar). There is also a separate section for micro and nano-scale applications.

You'll also find information on:

THREADS (10-32, 6-32, M6, etc.)

TUBING SIZE (1/16", 1/32", 360 μm, etc.)

PORT GEOMETRY (Coned, Flat-bottom)

Specification tables at the bottom of each page include:

- ▶ Part numbers
- ▶ Part description
- ▶ Materials of construction
- ▶ Standard size packages
- ▶ Pressure ratings
- ▶ Available colors

Additionally, you will find fitting-related application notes and, if available, special ordering options throughout the chapter.

Please Note: in the product descriptions, a "Fitting" refers to a complete product ready to assemble and connect tubing into a part. This could be a one-piece connector or a nut and ferrule packaged together. A "Nut" indicates the male or female threaded product sold separately, and a "Ferrule" is sold separately when indicated in the description. For your convenience we ship most Upchurch Scientific® Fittings and Ferrules in 10-packs, however, you may order individual pieces (an "x" in the product part number designates "10-pk").

You may notice a change in some of our pressure ratings — be assured that the IDEX Health & Science team is dedicated to providing the most reliable, proven products on the market. We have implemented more stringent testing protocols and a generous safety margin to our ratings to ensure your safety.

Please Note: all testing is performed with water at room temperature unless otherwise specified. Results may vary depending on the material of the receiving port and tubing, actual tubing diameters (with stated tolerances), temperature and solvents used. If a pressure range is listed for a product's specification, the pressure rating depends on the tubing material used. The lower end of the range will represent testing performed on softer tubing such as FEP, and the higher end of the range will represent testing performed on harder tubing such as Stainless Steel. For more detail, please see the product specification sheets on our website, www.idex-hs.com, or contact us directly.

FINGERTIGHT FITTINGS

Found on pages 11–15

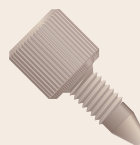

SUPER FLANGELESS™ FITTINGS

Found on pages 21–23

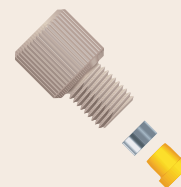

TUBING SLEEVES

Found on pages 19–20



MICROTIGHT® FITTINGS

Found on pages 18–19



FLANGELESS FITTINGS

Found on pages 24–26

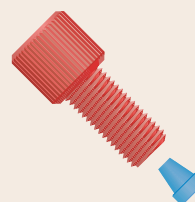

FLANGELESS FITTINGS FOR METRIC SIZED TUBING

Found on page 27

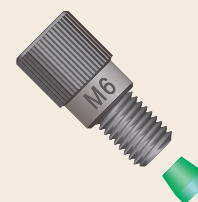

FITTINGS FOR 3/16" TO 5/16" OD TUBING

Found on page 30

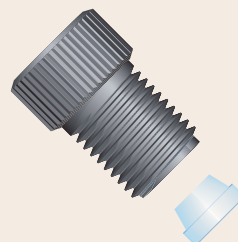

Reusable Very High Pressure (VHP) Fittings

- ▶ Pressure rated up to 25,000 psi (1,720 bar)
- ▶ Patent pending innovative design
- ▶ Capable of up to ten repeat assembly cycles with no impact on pressure holding ability or carry-over
- ▶ Available in 10-32 threads for 1/16" OD tubing and M4 threads for 1/32" OD tubing
- ▶ Materials of construction: stainless steel and proprietary PEEK polymer blend (PK)

IDEX Health & Science introduces an innovative line of Upchurch Scientific® Very High Pressure (VHP) fittings, designed to withstand extreme pressures. This patent-pending line of ground-breaking fitting systems is perfect for use within the increasingly demanding requirements of today's high performance analytical systems.

The Reusable VHP fittings can be reused when following the tightening torque specification listed below. With a polymer front ferrule, there is no damage to the tubing or receiving port, also increasing the life of these components.

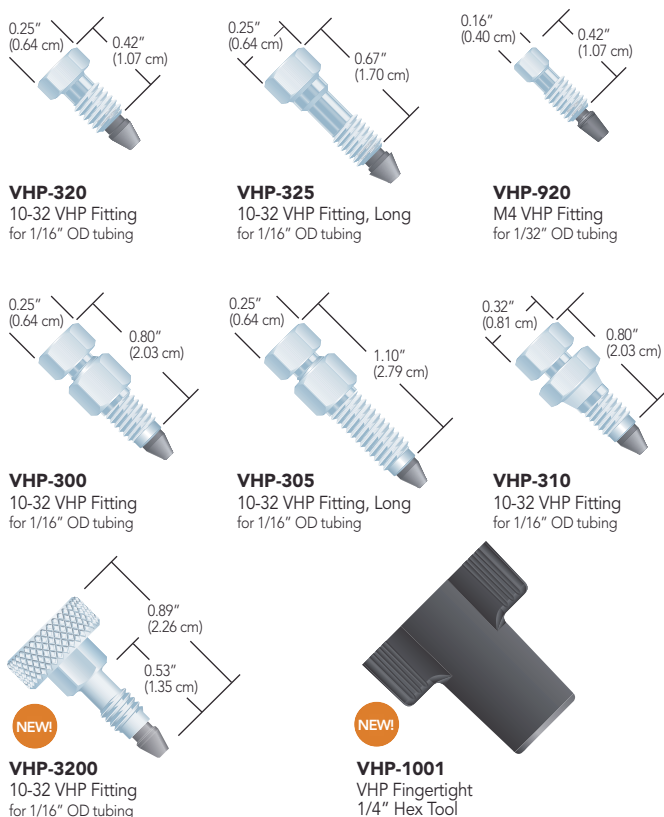

APPLICATION NOTE

Reusability

- ▶ Using a reusable fitting eliminates the problems described on stainless steel fitting interchangeability on page 185 of the Technical Resources section. A reusable fitting will allow for quick column, sample loop, inline filter or tubing changes with minimal downtime.
- ▶ The VHP-300, VHP-305, and VHP-310 fittings can be used up to 30,000 psi (2,070 bar) if tightened to 14 in-lbs (1.6 N·m). This limits the reusability to 5 cycles. The stacked design of these fittings allows the user to lightly assemble the fitting before tightening into the port. Leaving the tubing extended at least half an inch beyond the end of the ferrule will ensure that the tubing is bottomed out in the port before the fitting is tightened down, avoiding any potential dead volume that could be introduced during fitting installation.

RELATED PRODUCTS

- ▶ Find tightening tools on page 8 designed to deliver the torque necessary for these fittings.

Part No.	Description	Port	Pressure Rating	Required Torque	Head Style	Material	Qty.
REUSABLE VHP FITTINGS							
VHP-300x	VHP Fitting for 1/16" OD	10-32 Coned	20,000 psi (1,380 bar)	10 in-lbs (1.10 N·m)	1/4" Hex	SST/PK	10-pk
VHP-305x	VHP Fitting for 1/16" OD, Long	10-32 Coned	20,000 psi (1,380 bar)	10 in-lbs (1.10 N·m)	1/4" Hex	SST/PK	10-pk
VHP-310x	VHP Fitting for 1/16" OD	10-32 Coned	20,000 psi (1,380 bar)	10 in-lbs (1.10 N·m)	8 mm Hex	SST/PK	10-pk
VHP-320x	VHP Fitting for 1/16" OD	10-32 Coned	25,000 psi (1,720 bar)	10 in-lbs (1.10 N·m)	1/4" Hex	SST/PK	10-pk
VHP-325x	VHP Fitting for 1/16" OD, Long	10-32 Coned	25,000 psi (1,720 bar)	10 in-lbs (1.10 N·m)	1/4" Hex	SST/PK	10-pk
VHP-920x	VHP Fitting for 1/32" OD	M4 Coned	25,000 psi (1,720 bar)	8 in-lbs (0.90 N·m)	4 mm Hex	SST/PK	10-pk
NEW! VHP-3200	VHP Fitting for 1/16" OD	10-32 Coned	11,000 psi (760 bar)	3.5 in-lbs (0.40 N·m)	1/2" Knurl	SST/PK	10-pk
NEW! VHP-1001	VHP Fingertight 1/4" Hex Tool	—	—	—	—	PPS	ea.

Stainless Steel VHP Fittings

- ▶ Pressure rated to 30,000 psi (2,070 bar)
- ▶ Double compression ferrule design
- ▶ Available with 10-32 threads for 1/16" OD tubing and M4 threads for 1/32" OD tubing

The all Stainless-Steel VHP Fittings include a unique ferrule system with two compression points to provide twice the grip of a standard ferrule. This design also allows the bite on the tubing to be less concentrated and does not restrict the inner diameter, as discussed in the Application Note. The ferrules for 1/16" OD tubing and 10-32 coned ports are two pieces, while the grooved ferrule for 1/32" OD tubing and M4 coned ports is a one-piece design for easier handling, but it will act as two pieces with double compression on the tubing as it is tightened down.

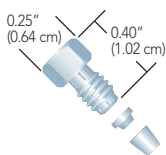

VHP-200
VHP 10-32 Fitting
for 1/16" OD tubing

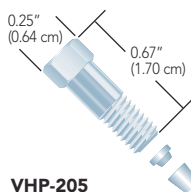

VHP-205
VHP 10-32 Fitting, Long
for 1/16" OD tubing



VHP-700
VHP 6-40 Fitting
for 1/32" OD tubing

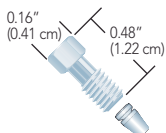

VHP-900
VHP M4 Fitting
for 1/32" OD tubing

APPLICATION NOTE

In order to seal up to the stated pressure rating, the VHP-200-01 ferrule requires 20 in-lbs (2.25 N·m) of torque. Similar ferrules on the market require tightening torque of at least 30 in-lbs (3.3 N·m), which can result in a restricted tubing passage, as shown in the picture below. This restriction can increase turbulence and add a 'throttling' effect to the fluid pathway, resulting in mixing and other potential chromatographic problems.

IDEX Health & Science VHP-200 Conventional Two Piece Ferrule Design

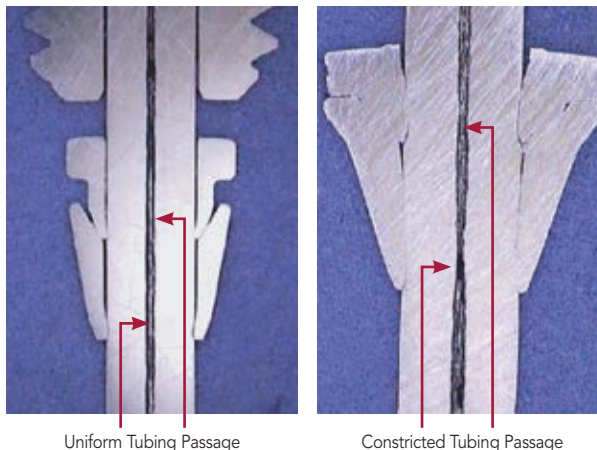

NEW!

Part No.	Description	Port	Pressure Rating	Required Torque	Head Style	Material	Qty.
STAINLESS STEEL VHP FITTINGS (INCLUDES NUT AND FERRULE)							
VHP-200x	VHP Fitting for 1/16" OD	10-32 Coned	30,000 psi (2,070 bar)	20 in-lbs (2.25 N·m)	1/4" Hex	SST	10-pk
VHP-205x	VHP Fitting for 1/16" OD, Long	10-32 Coned	30,000 psi (2,070 bar)	20 in-lbs (2.25 N·m)	1/4" Hex	SST	10-pk
VHP-900x	VHP Fitting for 1/32" OD	M4 Coned	30,000 psi (2,070 bar)	20 in-lbs (2.25 N·m)	4 mm Hex	SST	10-pk
VHP-700x	VHP Fitting for 1/32" OD	6-40 Coned	30,000 psi (2,070 bar)	20 in-lbs (2.25 N·m)	4 mm Hex	SST	10-pk
STAINLESS STEEL VHP FERRULES							
VHP-200-01x	VHP Ferrule for 1/16" OD	10-32 Coned	30,000 psi (2,070 bar)	20 in-lbs (2.25 N·m)	—	SST	10-pk
VHP-900-01x	VHP Ferrule for 1/32" OD	M4 Coned	30,000 psi (2,070 bar)	20 in-lbs (2.25 N·m)	—	SST	10-pk

Tightening Tools for VHP Fittings

- ▶ Configured for the optimum torque to provide assurance of a strong connection
- ▶ Prolongs the lifetime of reusable fittings by not overtightening
- ▶ Available for multiple fitting head styles

This new line of tightening tools is designed for the VHP fittings and can also be used with any fitting in this chapter described to have a corresponding head style to the tool listed below. There are three styles of tightening tools available for various applications. The Torque Tools (VHP-1000, VHP-2000, and VHP-3000) are breakaway torque wrenches designed to deliver a precise amount of torque to the fitting system. These torque wrenches come calibrated according to ISO 6789:2003 ($\pm 6\%$ of setting) and have been tested extensively with the reusable VHP fittings on page 6. Choose the appropriate torque delivered and the proper head style to work with the VHP fittings, increasing the ease of use with these fittings.

The VHP-4000 Torque Driver couples with the specially designed Extender Tools listed below and provides an externally adjustable torque setting. This tool along with the appropriate Extender Tools will tighten any Upchurch Scientific® knurled polymer fitting in your system. Reference the head style found in the tables at the bottom of each page for information on the proper Extender Tool to select.

Because of the small hex-head on the M4 fittings (VHP-900 and VHP-920), a custom wrench, the VHP-9000, is available below.

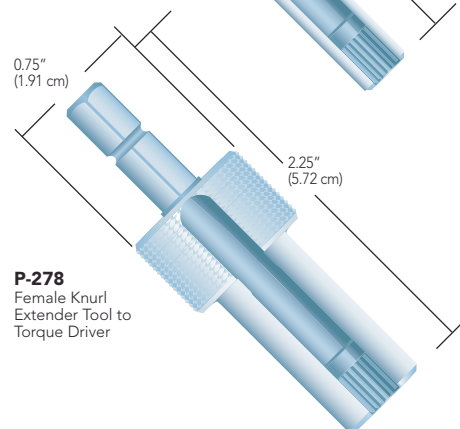
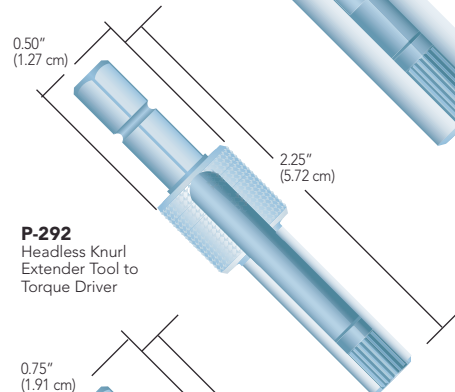
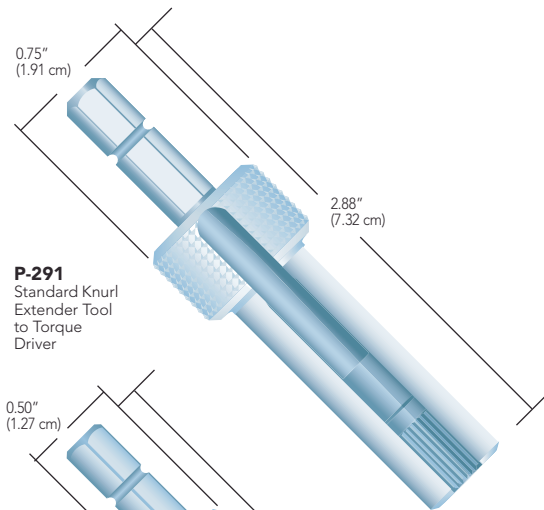

Part No.	Description	Use With Head Style	Torque Delivered	Qty.
VHP TIGHTENING TOOLS				
NEW! F-347	Extender Tool to Torque Driver	FlushNut (1/4-28)	—	ea.
NEW! N-291	Extender Tool to Torque Driver	Micro Headless	—	ea.
NEW! P-268	Extender Tool to Torque Driver	1/4" Hex	—	ea.
P-278	Extender Tool to Torque Driver	Female Nut Knurl	—	ea.
P-279	Extender Tool to Torque Driver	Micro Nut Knurl	—	ea.
P-291	Extender Tool to Torque Driver	Standard Nut Knurl	—	ea.
P-292	Extender Tool to Torque Driver	Headless Nut Knurl	—	ea.
P-1000	Standard Knurl Torque Tool	Standard Knurl	4 in-lbs (0.45 N·m)	ea.
VHP-1000	VHP Torque Tool	1/4" Hex	10 in-lbs (1.13 N·m)	ea.
VHP-2000	VHP Torque Tool	1/4" Hex	14 in-lbs (1.58 N·m)	ea.
VHP-3000	VHP Torque Tool	8 mm Hex	10 in-lbs (1.13 N·m)	ea.
VHP-4000	VHP Torque Driver	Extender Tool 1/4" Drive	Adjustable between 2–12 in-lbs (0.23–1.35 N·m)	ea.
VHP-9000	4 mm Wrench	4 mm Hex	—	ea.

Very High Pressure PK Fittings

Upchurch Scientific® Ultra High Performance fittings are manufactured from a proprietary PEEK blend (PK) which allow them to be used at higher temperatures (up to 200 °C) and higher pressures.

The VHP PK One-Piece fittings are available for 10-32 coned, 6-32 coned, or M4 coned ports, and Two-Piece fittings are available to connect either 1/16" or 1/32" OD tubing into 10-32 coned ports in multiple styles.

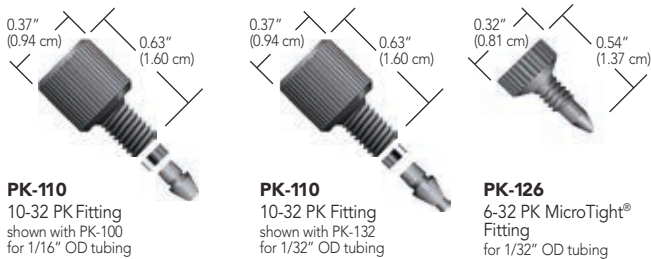

PK-110
10-32 PK Fitting
shown with PK-100
for 1/16" OD tubing

PK-110
10-32 PK Fitting
shown with PK-132
for 1/32" OD tubing

PK-126
6-32 PK MicroTight®
Fitting
for 1/32" OD tubing

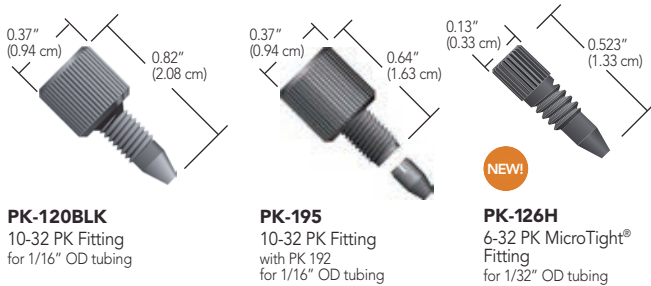

PK-120BLK
10-32 PK Fitting
for 1/16" OD tubing

PK-195
10-32 PK Fitting
with PK 192
for 1/16" OD tubing

PK-126H
6-32 PK MicroTight®
Fitting
for 1/32" OD tubing

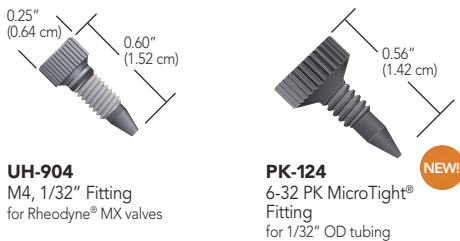

UH-904
M4, 1/32" Fitting
for Rheodyne® MX valves

PK-124
6-32 PK MicroTight®
Fitting
for 1/32" OD tubing

VHP MicroFerrules

VHP MicroFerrules are made from a proprietary high performance PEEK polymer blend, a material which is unique in its ability to enable the use of capillary tubing in UHPLC environments. The new high pressure MicroFerrules are available for use with 1/32" or 360 µm OD tubing, and they are incorporated into several of our VHP products for capillary tubing.

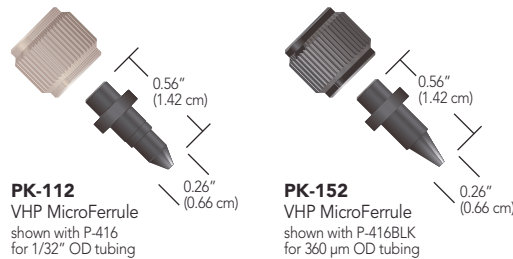

PK-112
VHP MicroFerrule
shown with P-416
for 1/32" OD tubing

PK-152
VHP MicroFerrule
shown with P-416BLK
for 360 µm OD tubing

APPLICATION NOTE

CAUTION: While the proprietary blend of the PK fittings will allow a fitting to attain a higher pressure and minimal cold flow properties relative to pure PEEK, some fittings molded of PK are known to be conductive. Use caution when employing PK fittings in high voltage applications.

NOTE

MicroTight fittings and MicroFerrules

While the MicroTight Female Nuts may be used with any of the separate MicroFerrules, the MicroFerrules themselves are port-specific and are thus not interchangeable. Additionally, the one-piece MicroTight fittings are also port-specific and should not be exchanged.

RELATED PRODUCTS

► Find unions, tees and crosses for VHP applications on pages 36, 37, and 42.

Part No.	Description	Port	Pressure Rating	Required Torque	Head Style	Material	Qty.
PK VHP ONE-PIECE FITTINGS							
★ PK-120BLKx	PK One-Piece Fitting for 1/16" OD Tubing	10-32 Coned	12,000 psi (827 bar)	8.0 in-lbs (0.90 N-m)	Standard Knurl	PK	10-pk
NEW! PK-124x	PK One-Piece Fitting for 360 µm OD Tubing	6-32 Coned	15,000 psi (1,035 bar)	3.0 in-lbs (0.34 N-m)	Standard Micro Knurl	PK	10-pk
NEW! PK-126Hx	PK One-Piece Headless Fitting for 1/32" OD Tubing	6-32 Coned	15,000 psi (1,035 bar)	3.0 in-lbs (0.34 N-m)	Headless Micro Knurl	PK	10-pk
PK-126x	PK One-Piece Fitting for 1/32" OD Tubing	6-32 Coned	15,000 psi (1,035 bar)	3.0 in-lbs (0.34 N-m)	Standard Micro Knurl	PK	10-pk
UH-904x	PK One-Piece Fitting for 1/32" OD Tubing	M4 Coned	15,000 psi (1,035 bar)	4.0 in-lbs (0.45 N-m)	Headless Knurl	PK	10-pk
PK VHP FITTINGS (SEALTIGHT™ STYLE, FITTINGS INCLUDE PK-192X)							
PK-192x	PK Ferrule for 1/16" OD Tubing	10-32 Coned	11,000 psi (760 bar)	—	—	PK	10-pk
PK-195x	PK Fitting for 1/16" OD Tubing	10-32 Coned	11,000 psi (760 bar)	8.0 in-lbs (0.90 N-m)	Standard Knurl	PK	10-pk
PK VHP FITTINGS (LITETOUCH® STYLE, NUTS AND FERRULES SOLD SEPARATELY)							
★ PK-100x	PK Ferrule for 1/16" OD Tubing	10-32 Coned	16,500 psi (1,140 bar)	—	—	PK	10-pk
PK-110x	PK Nut for 1/16" OD Tubing	10-32 Coned	16,500 psi (1,140 bar)	8.0 in-lbs (0.90 N-m)	Standard Knurl	PK	10-pk
PK-132x	PK Ferrule for 1/32" OD Tubing	10-32 Coned	16,500 psi (1,140 bar)	—	—	PK	10-pk
PK MICRO FERRULES AND FEMALE NUTS							
P-416	Female Nut for Microferrule	5/16-24 Coned	15,000 psi (1,035 bar)	4.0 in-lbs (0.45 N-m)	Female Knurl	PEEK, Natural	ea.
P-416BLK	Female Nut for Microferrule	5/16-24 Coned	15,000 psi (1,035 bar)	4.0 in-lbs (0.45 N-m)	Female Knurl	PEEK, Black	ea.
★ PK-112	VHP MicroFerrule for 1/32" OD Tubing	5/16-24 Coned	15,000 psi (1,035 bar)	—	—	PK	ea.
PK-152	VHP MicroFerrule for 360 µm OD Tubing	5/16-24 Coned	15,000 psi (1,035 bar)	—	—	PK	ea.

Stainless Steel Fittings

These 316 Stainless Steel Fittings are rated to 20,000 psi (1,380 bar) when wrench tightened. Choose Upchurch Scientific® Standard Fittings, or select from the Rheodyne® or other manufacturer-compatible offerings.

Standard Stainless Steel Fittings

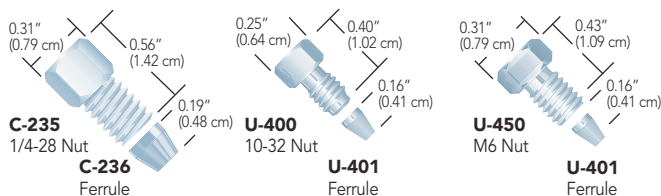

Rheodyne Fittings

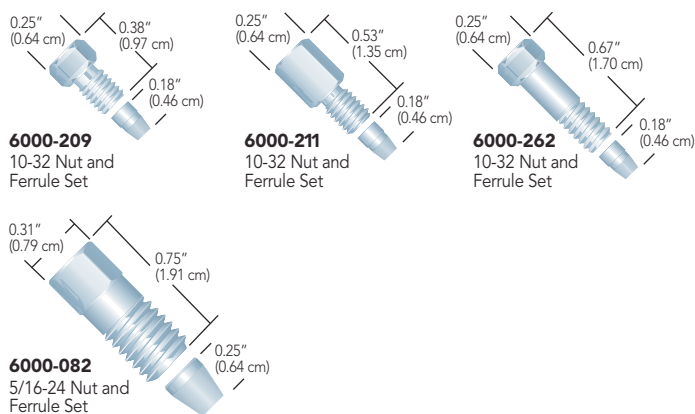

SSI Compatible Fittings

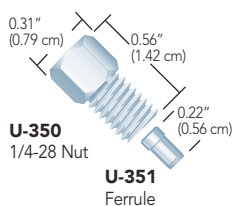

Beckman® Compatible Fittings

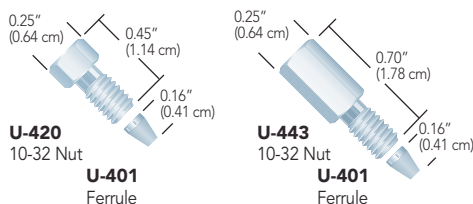

VICI® (Valco) Compatible Fittings

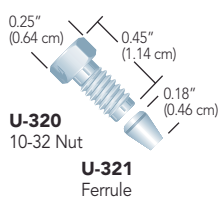

Waters® Compatible Fittings

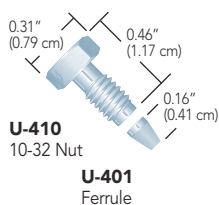

NOTE

- ▶ Do not use metal fittings in plastic ports, as this can damage the port. Please see the "Material Structural Compatibility" chart on page 184 for more information about fittings compatibility with tubing and port materials.
- ▶ The recommended torque to tighten these fittings is 20 in-lbs (2.25 N·m).

Part No.	Description	Port	Pressure Rating	Head Style	Material	Qty.
STANDARD STAINLESS STEEL FITTINGS						
C-235x	Nut for 1/8" OD Tubing	1/4-28 Coned	20,000 psi (1,380 bar)	5/16" Hex	SST	10-pk
C-236x	Ferrule for 1/8" OD Tubing	1/4-28 Coned	20,000 psi (1,380 bar)	—	SST	10-pk
★ U-400x	Nut for 1/16" OD Tubing	10-32 Coned	20,000 psi (1,380 bar)	1/4" Hex	SST	10-pk
★ U-401x	Ferrule for 1/16" OD Tubing	10-32 or M6 Coned	20,000 psi (1,380 bar)	—	SST	10-pk
U-450x	Nut for 1/16" OD Tubing	M6 Coned	20,000 psi (1,380 bar)	5/16" Hex	SST	10-pk
RHEODYNE FITTINGS						
6000-082	Fitting for 1/8" OD Tubing	5/16-24 Coned	20,000 psi (1,380 bar)	5/16" Hex	SST	ea.
6000-083	Ferrule for 1/8" OD Tubing	5/16-24 Coned	20,000 psi (1,380 bar)	—	SST	5-pk
6000-209	Fitting for 1/16" OD Tubing	10-32 Coned	20,000 psi (1,380 bar)	1/4" Hex	SST	10-pk
6000-210	Ferrule for 1/16" OD Tubing	10-32 Coned	20,000 psi (1,380 bar)	—	SST	10-pk
6000-211	Fitting for 1/16" OD Tubing, Long	10-32 Coned	20,000 psi (1,380 bar)	1/4" Hex	SST	10-pk
6000-262	Fitting for 1/16" OD Tubing, Extra Long	10-32 Coned	20,000 psi (1,380 bar)	1/4" Hex	SST	10-pk
MANUFACTURER COMPATIBLE FITTINGS						
★ U-320x	Nuts for 1/16" OD Tubing, Valco/VICI Compatible	10-32 Coned	20,000 psi (1,380 bar)	1/4" Hex	SST	10-pk
★ U-321x	Ferrule for 1/16" OD Tubing, Valco/VICI Compatible	10-32 Coned	20,000 psi (1,380 bar)	—	SST	10-pk
U-350x	Nuts for 1/16" OD Tubing, SSI Compatible	10-32 Coned	20,000 psi (1,380 bar)	5/16" Hex	SST	10-pk
U-351x	Ferrule for 1/16" OD Tubing, SSI Compatible	10-32 Coned	20,000 psi (1,380 bar)	—	SST	10-pk
★ U-410x	Nuts for 1/16" OD Tubing, Waters Compatible	10-32 Coned	20,000 psi (1,380 bar)	5/16" Hex	SST	10-pk
U-420x	Nuts for 1/16" OD Tubing, Beckman Compatible	10-32 Coned	20,000 psi (1,380 bar)	1/4" Hex	SST	10-pk
U-443x	Nuts for 1/16" OD Tubing, Beckman Compatible, Long	10-32 Coned	20,000 psi (1,380 bar)	1/4" Hex	SST	10-pk

One-Piece Fingertight Fittings

- ▶ The original One-Piece Fingertight Fitting
- ▶ All polymer construction
- ▶ Versions available for 1/16", 1/32" or 1/8" OD tubing

The Upchurch Scientific® One-Piece Fingertight Fittings provide convenience and ease of use because the ferrule will not stick in a receiving port and the fitting is more easily found if dropped. The fittings for 1/16" OD tubing and 10-32 coned ports are available in a variety of colors, materials and lengths to suit virtually every application.

Beyond the standard 10-32 fittings, also featured in this product family are specialty fittings for specific applications. Our M-645 Fitting is a direct replacement for the 6-40 threaded VICI® (Valco) fitting. The P-100 can be used in 1/4-28 coned ports for 1/8" OD tubing including some of the inlet filters starting on page 157.

RheFlex® One-Piece Fittings are included in many of the Rheodyne® manual valves, starting on page 132. The One-Piece RheFlex M4 Fittings, for use with Rheodyne MX Nano-Scale Modules, are listed on page 12.

NOTE

- ▶ For your convenience we ship most Upchurch Scientific Fingertight Fittings in 10-packs. However, you may order individual pieces (the letter "x" in the product part number simply designates "10-pk").
- ▶ Some of the Upchurch Scientific fittings on this page are available in additional colors. Please contact your distributor or us for more information.
- ▶ The F-120FUN PACK includes six F-120 Fittings in the following colors: natural, blue, black, green, red, and yellow.
- ▶ Fingertight is generally equal to 3–4 in-lbs (0.34–0.45 N·m).

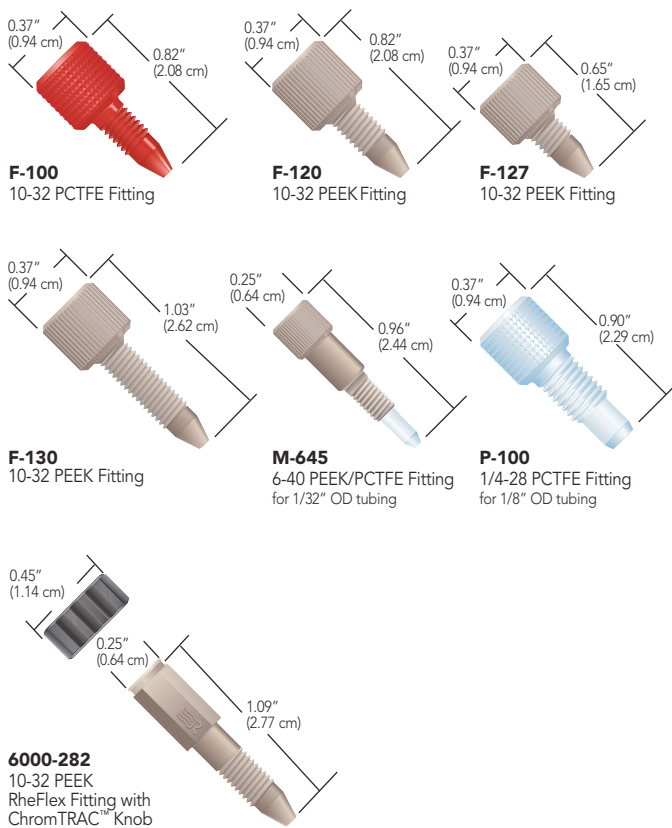

Part No.	Description	Port	Pressure Rating	Head Style	Material	Qty.
ONE-PIECE FINGERTIGHT FITTINGS						
6000-282	Fingertight Fitting for 1/16" OD Tubing	10-32 Coned	5,000 psi (345 bar)	ChromTRAC knob	PEEK, Natural	10-pk
F-100x	Fingertight Fitting for 1/16" OD Tubing	10-32 Coned	4,000 psi (276 bar)	Diamond Knurl	PCTFE, Red	10-pk
F-100Nx	Fingertight Fitting for 1/16" OD Tubing	10-32 Coned	4,000 psi (276 bar)	Diamond Knurl	PCTFE, Natural	10-pk
★ F-120x	Fingertight Fitting for 1/16" OD Tubing	10-32 Coned	5,000 psi (345 bar)	Standard Knurl	PEEK, Natural	10-pk
F-120FUN PACK	Fingertight Fitting for 1/16" OD Tubing	10-32 Coned	5,000 psi (345 bar)	Standard Knurl	PEEK, Natural, Blue, Black, Green, Red, Yellow (one each color)	6-pk
F-127x	Fingertight Fitting for 1/16" OD Tubing, Short	10-32 Coned	5,000 psi (345 bar)	Standard Knurl	PEEK, Natural	10-pk
★ F-130x	Fingertight Fitting for 1/16" OD Tubing, Long	10-32 Coned	5,000 psi (345 bar)	Standard Knurl	PEEK, Natural	10-pk
M-645x	Fingertight Fitting for 1/32" OD Tubing	6-40 Coned	1,750–3,250 psi (121–224 bar)	Headless Knurl	PEEK, Natural/PCTFE, Natural	10-pk
P-100	Fingertight Fitting for 1/8" OD Tubing	1/4-28 Coned	1,000 psi (69 bar)	Diamond Knurl	PCTFE, Natural	ea.

Sure-Fit™ Connector

- ▶ Self-adjusting to any port depth regardless of column manufacturer
- ▶ Fingertight to 6,000 psi (414 bar)
- ▶ Available in PEEK or stainless steel



Eliminating leaks and dead volume is critical to achieving good chromatographic results. The Sure-Fit connector gives you a perfect fit in nearly every 10-32 coned receiving port — every connection, every time. Typically leaks and dead volume are caused by an improperly plumbed system and can occur for many reasons, including

switching columns. The problem occurs not only when switching from one manufacturer to another, it can also occur when changing columns from the same manufacturer. This is because internal port depths vary, even within the same manufacturing lot. Unless the connector is universal, eliminating leaks and dead volume cannot be guaranteed. The Sure-Fit connector has a unique internal spring-tensioned mechanism that automatically self-adjusts to virtually any port depth while maintaining constant pressure on the 1/16" OD tubing.

Sure-Fit connectors come with either PEEK tubing or stainless steel tubing, in varying lengths and internal diameters, pre-assembled for ease of use. Choose the 9502-01007-HP — a U-shaped Sure-Fit connector — for use in Agilent® 1100 systems, or select the 9504-01005-050 for micro-scale applications where biocompatibility is desired.

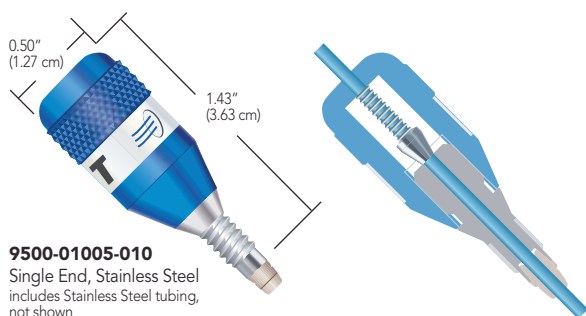

9500-01005-010
Single End, Stainless Steel
includes Stainless Steel tubing,
not shown

RheFlex® M4 Fittings

- ▶ Incorporates M4 coned threads for 1/32" OD tubing
- ▶ Pressure rated to 5,000 psi (345 bar)

The Rheodyne® RheFlex M4 Fitting is designed to connect 1/32" OD tubing in MX Series II™ valves (see Actuated Valves, starting on page 130). This PEEK fitting has a one piece design, which eliminates the need for a separate nut and ferrule. The M4 Fitting design provides dependable zero dead volume connections for micro and nano applications. Due to the unique RheFlex gripping design, the M4 Fitting will hold to 5,000 psi (345 bar) on PEEK or with a PEEK tubing sleeve on fused silica tubing. A PEEK M4 Plug is also available.

Use Rheodyne ChromTRAC™ knobs with the RheFlex M4 Fitting for fingertight convenience and to color-code connections.

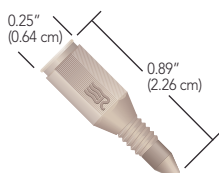

6000-360
M4 Fitting
M4 threads
for 1/32" OD tubing

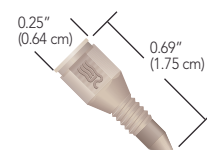

6000-361
M4 Plug
M4 threads

Part No.	Description	Port	Pressure Rating	Head Style	Material	Qty.
SURE-FIT FITTINGS						
9500-01005-010	Single End Fitting, 1/16" x 0.005" x 10 cm	10-32 Coned	6,000 psi (414 bar)	Diamond Knurl	SST	ea.
9500-01007-010	Single End Fitting, 1/16" x 0.007" x 10 cm	10-32 Coned	6,000 psi (414 bar)	Diamond Knurl	SST	ea.
9500-01010-010	Single End Fitting, 1/16" x 0.010" x 10 cm	10-32 Coned	6,000 psi (414 bar)	Diamond Knurl	SST	ea.
9500-01020-030	Single End Fitting, 1/16" x 0.020" x 30 cm	10-32 Coned	6,000 psi (414 bar)	Diamond Knurl	SST	ea.
9502-01007-HP	Single End Fitting, 1/16" x 0.007", U-Shape for Agilent 1100 System	10-32 Coned	6,000 psi (414 bar)	Diamond Knurl	SST	ea.
9504-01005-050	Single End Fitting, 1/16" x 0.005" x 50 cm	10-32 Coned	6,000 psi (414 bar)	Diamond Knurl	PEEK, Natural	ea.
9504-01007-050	Single End Fitting, 1/16" x 0.007" x 50 cm	10-32 Coned	6,000 psi (414 bar)	Diamond Knurl	PEEK, Natural	ea.
9504-01010-050	Single End Fitting, 1/16" x 0.010" x 50 cm	10-32 Coned	6,000 psi (414 bar)	Diamond Knurl	PEEK, Natural	ea.
SURE-FIT FITTINGS REPLACEMENT PARTS						
9500-FP	Replacement Ferrule	10-32 Coned	6,000 psi (414 bar)	—	PEEK, Natural	ea.*
RHEFLEX ONE-PIECE FITTINGS						
6000-360	RheFlex Fitting for 1/32" OD Tubing	M4 Coned	5,000 (345 bar)	1/4" Hex	PEEK, Natural	10-pk
6000-361	RheFlex Plug	M4 Coned	5,000 (345 bar)	1/4" Hex	PEEK, Natural	10-pk

* Minimum order quantity of 100.

Two-Piece RheFlex® Fingertight Fittings

The Rheodyne® RheFlex Precision Two-Piece PEEK Fittings sets provide inert, biocompatible connections for instrumentation. These fittings have a reliable, time-tested design. Each 1/16" fittings set contains a 10-32 threaded nut and a specially-designed PEEK ferrule. Three lengths of the 1/16" nut are available: Standard, Short, and Extra Long. RheFlex Fingertight Fittings are rated for use up to 7,000 psi (483 bar). Also offered in this product line is the 6000-078 fitting, designed to connect 1/8" OD tubing into our manual preparative-scale injection valves. (See pages 128–134 for more information on these valves.)

View the online product bulletin at: www.idex-hs.com.

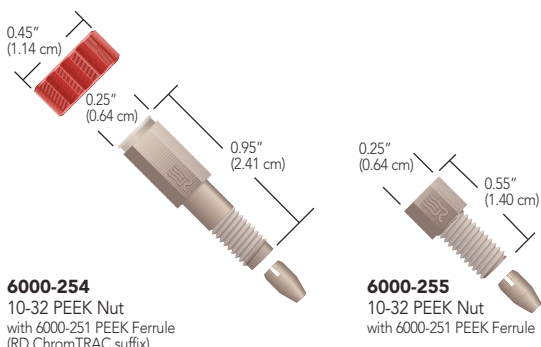

6000-254
10-32 PEEK Nut
with 6000-251 PEEK Ferrule
(RD ChromTRAC suffix)

6000-255
10-32 PEEK Nut
with 6000-251 PEEK Ferrule

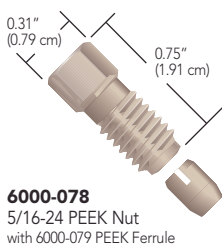

6000-078
5/16-24 PEEK Nut
with 6000-079 PEEK Ferrule



ChromTRAC™

- ▶ Brightly colored knobs to easily track inlets and outlets of valves, columns, and detectors

All ChromTRAC-compatible RheFlex fittings offer the ChromTRAC knob option. Specify the ChromTRAC two letter suffix for the color choice when ordering. Please see the ChromTRAC Suffix Codes table below. For example, to order red ChromTRAC knobs with the RheFlex One-Piece Fitting on this page, specify 6000-282RD. No suffix indicates black knobs.

View the online product bulletin for RheFlex fittings at: www.idex-hs.com.

CHROMTRAC SUFFIX CODES

CODE	COLOR
BL	Blue
GN	Green
GY	Gray
RD	Red
WH	White
YL	Yellow
MC	Multi-color (two each of blue, green, gray, red, and yellow)

Add these letter suffixes to the end of the seven-digit part numbers of the 10-32 and M4 threaded RheFlex Fittings on pages 11, 12, and 13.

RELATED PRODUCTS

- ▶ For PEEK tubing sleeves that can be used with these M4 RheFlex fittings, see page 20.
- ▶ For reusable fittings that both work in UHPLC applications and can help ensure the tubing is fully inserted into the receiving port, see the VHP-300 fitting shown earlier in this chapter on page 6.

Part No.	Description	Port	Pressure Rating	Head Style	Material	Qty.
RHEFLEX TWO-PIECE FITTINGS (INCLUDES FERRULES)						
6000-078	RheFlex Fitting for 1/8" OD Tubing	5/16-24 Coned	5,000 psi (345 bar)	5/16" Hex	PEEK, Natural	ea.
6000-254	RheFlex Fitting for 1/16" OD Tubing	10-32 Coned	7,000 psi (483 bar)	ChromTRAC knob	PEEK, Natural	10-pk
6000-255	RheFlex Fitting for 1/16" OD Tubing, Short	10-32 Coned	7,000 psi (483 bar)	1/4" Hex	PEEK, Natural	10-pk
REPLACEMENT FERRULES						
6000-079	RheFlex Ferrule for 1/8" OD Tubing	5/16-24 Coned	7,000 psi (483 bar)	ChromTRAC knob	PEEK, Natural	5-pk
6000-251	RheFlex Ferrule for 1/16" OD Tubing	10-32 Coned	7,000 psi (483 bar)	ChromTRAC knob	PEEK, Natural	10-pk

Two-Piece SealTight™ Fingertight Fittings

- ▶ Several nut lengths and head styles to fit into a variety of applications
- ▶ Designed to connect 1/16" OD tubing to 10-32 coned ports
- ▶ Hold up to 9,000 psi (620 bar)

The dual compression created by the specially designed nut and ferrule enables the Upchurch Scientific® SealTight Fittings system to outperform standard finger tightened fittings. The forward cone of the SealTight Ferrule provides gripping power and a leak-free seal via conventional compression by the receiving port. The slotted end creates the second compression zone in conjunction with a SealTight Nut. All SealTight Nuts are for use with 1/16" OD tubing and are designed to be used with the F-192 Ferrule. A wide variety of fitting head styles are available for various space constraints. This fittings system is also interchangeable with the Two-Piece RheFlex® Fittings System for 1/16" OD tubing, shown on the previous page.

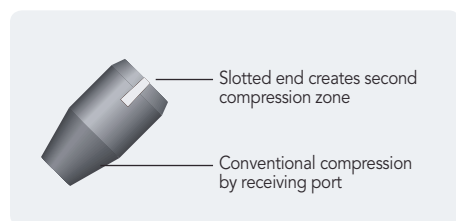

NOTE

Overtightening these fittings on fluoropolymer (e.g., FEP, PFA, and ETFE) tubing can cause the ID of your tubing to collapse.

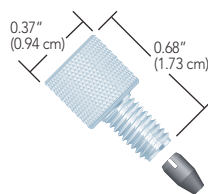

F-190
10-32 Standard
Stainless Steel Nut,
with F-192 Ferrule

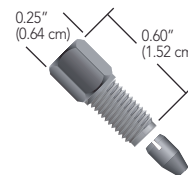

F-193
10-32 Short PEEK
Hex Head Nut,
with F-192 Ferrule

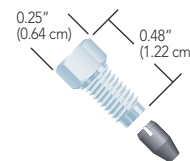

F-194
10-32 Short Stainless
Steel Hex Head Nut,
with F-192 Ferrule

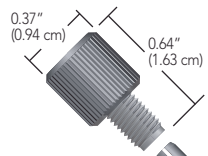

F-195
10-32 Short PEEK Nut,
with F-192 Ferrule

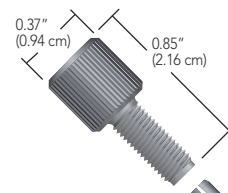

F-196
10-32 Long PEEK Nut,
with F-192 Ferrule

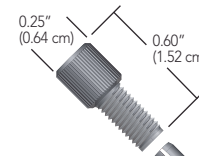

F-198
10-32 Short PEEK
Headless Nut,
with F-192 Ferrule

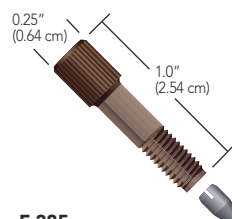

F-285
10-32 Long PPS
Headless Nut,
with F-192 Ferrule

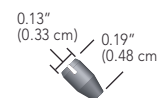

F-192
SealTight Ferrule,
for 1/16" OD tubing

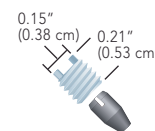

F-350
10-32 Stainless
Steel FlushNut,
with F-192 Ferrule

RELATED PRODUCTS

- ▶ Find tightening tools for these fittings on page 33.
- ▶ Try the F-350 FlushNut™ for the ultimate streamline design. For more information on these innovative products, please see page 31.

Part No.	Description	Port	Pressure Rating	Head Style	Material	Qty.
SEALTIGHT TWO-PIECE FITTINGS (INCLUDES F-192 FERRULES)						
F-190x	SealTight Fitting for 1/16" OD Tubing	10-32 Coned	7,000–9,000 psi (483–620 bar)	Standard Knurl	SST	10-pk
★ F-193x	SealTight Fitting for 1/16" OD Tubing, Short	10-32 Coned	7,000–9,000 psi (483–620 bar)	1/4" Hex	PEEK Black	10-pk
F-194x	SealTight Fitting for 1/16" OD Tubing, Short	10-32 Coned	7,000–9,000 psi (483–620 bar)	1/4" Hex	SST	10-pk
F-195x	SealTight Fitting for 1/16" OD Tubing, Short	10-32 Coned	7,000–9,000 psi (483–620 bar)	Standard Knurl	PEEK Black	10-pk
★ F-196x	SealTight Fitting for 1/16" OD Tubing, Long	10-32 Coned	7,000–9,000 psi (483–620 bar)	Standard Knurl	PEEK Black	10-pk
F-198x	SealTight Fitting for 1/16" OD Tubing, Short	10-32 Coned	3,000–9,000 psi (207–620 bar)	Headless Knurl	PEEK Black	10-pk
F-284x	SealTight Fitting for 1/16" OD Tubing, Long	10-32 Coned	3,000–9,000 psi (207–620 bar)	Headless Knurl	PEEK Black	10-pk
F-285x	SealTight Fitting for 1/16" OD Tubing, Long	10-32 Coned	3,000–9,000 psi (207–620 bar)	Headless Knurl	PPS Brown	10-pk
F-287x	SealTight Fitting for 1/16" OD Tubing, Long	10-32 Coned	7,000–9,000 psi (483–620 bar)	Knurl-1/4" Hex	PEEK Black	10-pk
F-350x	SealTight Fitting for 1/16" OD Tubing, FlushNut	10-32 Coned	7,000–9,000 psi (483–620 bar)	FlushNut	SST	10-pk
REPLACEMENT FERRULES						
★ F-192x	SealTight Ferrule for 1/16" OD Tubing	10-32 or M6 Coned	7,000–9,000 (483–620 bar)	—	PEEK/Black	10-pk

Two-Piece Fingertight Fittings

- ▶ Designed to connect tubing to 10-32 coned ports
- ▶ Ferrules available for directly connecting 1/16", 1/32", 360 µm, or 190 µm OD tubing

Two-Piece Fingertight Fittings feature a separate ferrule. With a two-piece design, you can replace just the ferrule instead of the entire unit, making these Fingertights more economical than the one-piece version. Use a standard knurled head fitting for traditional fingertight applications, or use a fitting with wings built into the head for extra tightening leverage. A stainless steel hex headed fitting can be used for applications where a wrench may be needed for added tightening torque.

To order the fittings as shown to the right, simply reference the part numbers as indicated. To exchange the ferrule typically packaged with our fittings with one of our specialty ferrules shown below, simply replace the letter "x" in the part number with a "-01", and then specify the ferrule needed on a separate line. For example, to order the F-140 fitting with the M-215 ferrule, specify F-140-01 and M-215 separately. *Please note: all "-01" fittings are packaged individually, not in 10-packs.*

The M-215 Conductive Perfluoroelastomer Ferrule is designed for mass spectrometer electrospray applications. Unlike most graphite ferrules, the elastomeric properties of this ferrule let you use it through many tightening/retightening cycles. It also eliminates any possibility of graphite contamination in your system. Like graphite ferrules, you can apply voltage through a metallic port block or metallic nut, allowing voltage to translate to the flow path through the ferrule.

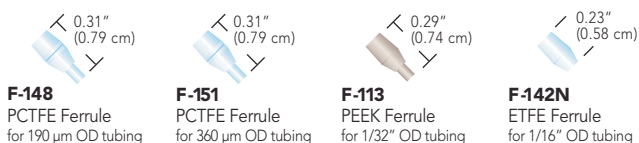

F-148
PCTFE Ferrule
for 190 µm OD tubing

F-151
PCTFE Ferrule
for 360 µm OD tubing

F-113
PEEK Ferrule
for 1/32" OD tubing

F-142N
ETFE Ferrule
for 1/16" OD tubing



M-215
Conductive Perfluoroelastomer Ferrule
for 360 µm OD tubing

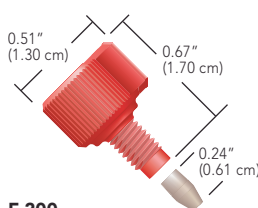

F-200
10-32 Delrin® Winged Nut
with F-142 PEEK Ferrule

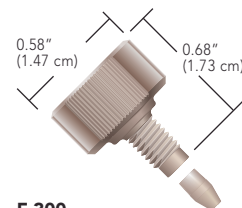

F-300
10-32 PEEK Double-Winged Nut
with F-142 PEEK Ferrule

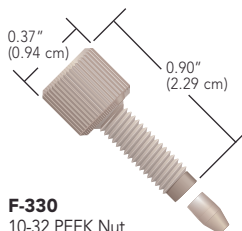

F-330
10-32 PEEK Nut
with F-142 PEEK Ferrule

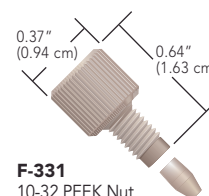

F-331
10-32 PEEK Nut
with F-142 PEEK Ferrule

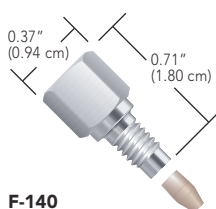

F-140
10-32 Stainless Steel Nut
with F-142 PEEK Ferrule

APPLICATION NOTE



Some Upchurch Scientific® Fingertight Nuts feature wings in addition to a knurled head, which provide more leverage when tightening the fitting into a receiving port. Choose our single or double-winged design.

Please Note: customers can use the standard knurl head fittings with our tightening tools found on page 33.

Part No.	Description	Port	Pressure Rating	Head Style	Material	Qty.
TWO-PIECE FINGERTIGHT FITTINGS (INCLUDES F-142 FERRULES)						
F-140x	Fitting for 1/16" OD Tubing	10-32 Coned	6,000 psi (414 bar)	5/16" Hex	SST/PEEK Natural	10-pk
F-200x	Fingertight Fitting for 1/16" OD Tubing	10-32 Coned	6,000 psi (414 bar)	Single Wing	Delrin Red/PEEK Natural	10-pk
★ F-300x	Fingertight Fitting for 1/16" OD Tubing	10-32 Coned	6,000 psi (414 bar)	Double Wing	PEEK Natural	10-pk
★ F-330x	Fingertight Fitting for 1/16" OD Tubing, Long	10-32 Coned	6,000 psi (414 bar)	Standard Knurl	PEEK Natural	10-pk
F-331x	Fingertight Fitting for 1/16" OD Tubing	10-32 Coned	6,000 psi (414 bar)	Standard Knurl	PEEK Natural	10-pk
REPLACEMENT FERRULES						
★ F-113	Ferrule for 1/32" OD Tubing	10-32 Coned	6,000 psi (414 bar)	—	PEEK Natural	ea.
F-142x	Ferrule for 1/16" OD Tubing	10-32 Coned	6,000 psi (414 bar)	—	PEEK Natural	10-pk
F-142Nx	Ferrule for 1/16" OD Tubing	10-32 Coned	4,000 psi (276 bar)	—	ETFE Natural	10-pk
F-148	Ferrule for 190 µm OD tubing	10-32 Coned	6,000 psi (414 bar)	—	PCTFE Natural	ea.
F-151	Ferrule for 360 µm OD Tubing	10-32 Coned	6,000 psi (414 bar)	—	PCTFE Natural	ea.
★ M-215	Conductive Ferrule for 360 µm OD tubing	10-32 Coned	1,500 psi (103 bar)	—	Conductive Perfluoroelastomer	ea.

LiteTouch® Fittings

- ▶ Helps prevent twisting of polymer tubing
- ▶ High pressure with fingertight convenience
- ▶ Options available for 1/32", 1/16", or 1/8" OD tubing

The LiteTouch Fittings System grips tubing at two compression points (see diagram), holding to high pressures with Fingertight convenience. It also prevents polymer tubing from twisting, a potential problem when using standard Fingertight fittings. LiteTouch Fittings are available for use with 1/32", 1/16", or 1/8" OD tubing sizes, and for 10-32 or 1/4-28 coned ports.

For those space-limited applications where nut heads interfere with each other, try the FlushNut™ Fittings. (FlushNut Fittings require a tightening tool. Please see page 31 for more information about these products.)

To avoid collapsing the ID of your tubing, the LiteTouch system can be used on hard tubing only, such as stainless steel and PEEK polymer tubing. The LiteTouch Ferrule System is not recommended for repeated use in plastic ports.

LiteTouch Fittings Systems

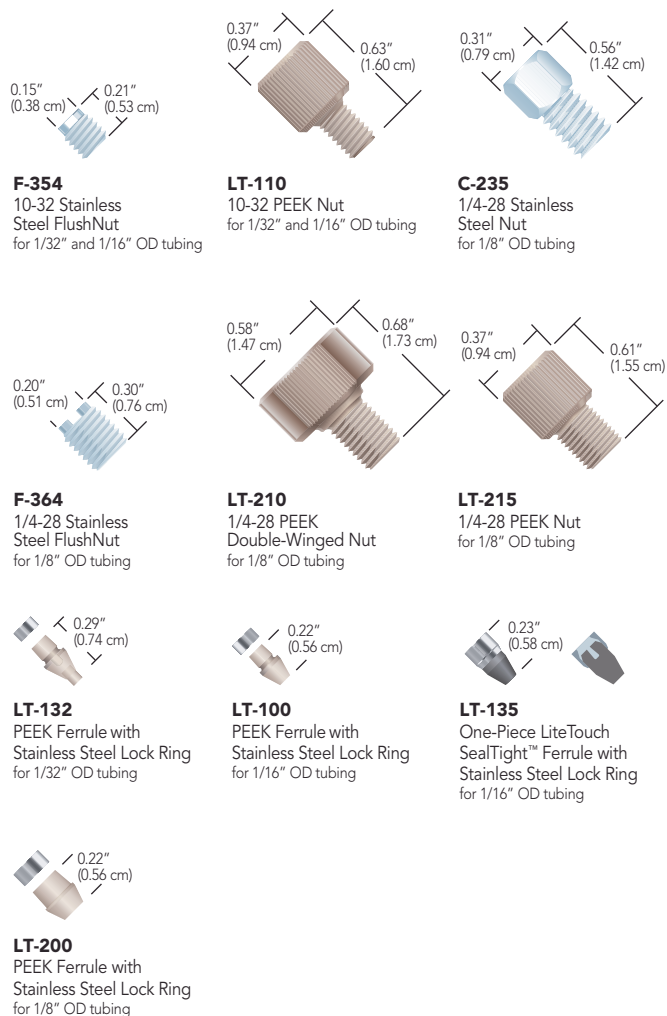
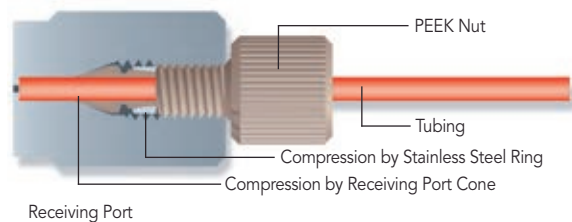

RELATED PRODUCTS

- ▶ The stainless steel nuts on page 10 can also be used with the LiteTouch ferrules on this page.

Part No.	Description	Port	Pressure Rating	Head Style	Material	Qty.
LITETOUCH NUTS						
C-235x	LiteTouch Nut for 1/8" OD Tubing	1/4-28 Coned	4,500 psi (310 bar)	5/16" Hex	SST	10-pk
F-354x	LiteTouch Nut for 1/16" or 1/32" OD Tubing, FlushNut	10-32 Coned	5,000 psi (345 bar)	FlushNut	SST	10-pk
F-364x	LiteTouch Nut for 1/8" OD Tubing, FlushNut	1/4-28 Coned	4,500 psi (310 bar)	FlushNut	SST	10-pk
LT-110x	LiteTouch Nut for 1/16" or 1/32" OD Tubing	10-32 Coned	5,000 psi (345 bar)	Standard Knurl	PEEK Natural	10-pk
LT-210x	LiteTouch Nut for 1/8" OD Tubing	1/4-28 Coned	4,500 psi (310 bar)	Double Wing	PEEK Natural	10-pk
LT-215x	LiteTouch Nut for 1/8" OD Tubing, Short	1/4-28 Coned	4,500 psi (310 bar)	Standard Knurl	PEEK Natural	10-pk
LITETOUCH FERRULES						
★ LT-100x	LiteTouch Ferrule for 1/16" OD Tubing	10-32 Coned	5,000 psi (345 bar)	—	PEEK Natural/SST	10-pk
★ LT-132x	LiteTouch Ferrule for 1/32" OD Tubing	10-32 Coned	5,000 psi (345 bar)	—	PEEK Natural/SST	10-pk
★ LT-135x	LiteTouch Ferrule for 1/16" OD Tubing	10-32 Coned	10,000 psi (690 bar)*	—	PEEK Black/SST	10-pk
LT-200x	LiteTouch Ferrule for 1/8" OD Tubing	1/4-28 Coned	4,500 psi (310 bar)	—	PEEK Natural/SST	10-pk

* When used with a stainless steel 10-32 nut from page 10.

NanoTight™ Fittings & Sleeves

- ▶ For connecting 1/16" OD or capillary tubing using tubing sleeves to standard 10-32 coned ports
- ▶ Multiple nut styles available
- ▶ Nuts manufactured from PEEK polymer, ferrules manufactured from ETFE

Upchurch Scientific® NanoTight Fittings and Sleeves are designed to connect 70 µm–1 mm OD capillary tubing to any standard 10-32 coned port normally intended for 1/16" OD tubing using the NanoTight Tubing Sleeves on page 19. The fittings can also be used to connect any 1/16" OD tubing. The ETFE ferrule material is softer than PEEK, making it a good candidate for connecting thin walled semi-rigid tubing such as FEP and ETFE into 10-32 ports with minimal constricting to the inner diameter.

Select from our expansive line of PEEK NanoTight Fittings, featuring several head style and length options. Each 10-pack of nuts includes ten ETFE F-142N ferrules.

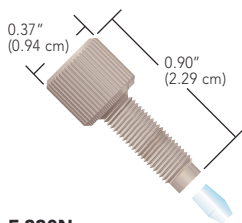

F-330N
Long Standard Head Nut
with F-142N Ferrule



F-331N
Short Standard Head Nut
with F-142N Ferrule

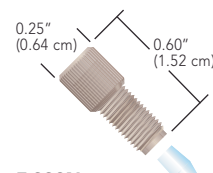

F-333N
Short Headless Nut
with F-142N Ferrule

RELATED PRODUCTS

- ▶ Find tightening tools for these head styles on page 33.
- ▶ NanoTight Tubing sleeves start on page 19.

Part No.	Description	Port	Pressure Rating	Head Style	Material (Nut/Ferrule)	Qty.
NANOTIGHT FITTINGS (INCLUDES F-142N FERRULES)						
★ F-330Nx	NanoTight Fitting for 1/16" OD Tubing and NanoTight Sleeves	10-32 Coned	4,000 psi (276 bar)	Standard Knurl	PEEK Natural/ETFE Natural	10-pk
F-331Nx	NanoTight Fitting for 1/16" OD Tubing and NanoTight Sleeves, Short	10-32 Coned	4,000 psi (276 bar)	Standard Knurl	PEEK Natural/ETFE Natural	10-pk
★ F-333Nx	NanoTight Fitting for 1/16" OD Tubing and NanoTight Sleeves, Short	10-32 Coned	4,000 psi (276 bar)	Headless Knurl	PEEK Natural/ETFE Natural	10-pk
REPLACEMENT FERRULES						
F-142Nx	NanoTight Ferrule for 1/16" OD Tubing and NanoTight Sleeves	10-32 Coned	4,000 psi (276 bar)	—	ETFE Natural	10-pk

MicroTight® Fittings

- ▶ Comprehensive Fitting System for Connecting Capillary Tubing
- ▶ Made from PEEK Polymer

Upchurch Scientific® MicroTight One-Piece Fittings are designed for use with the NanoPort™ and MicroTight Unions, Adapters and Inline MicroFilters. Specifically made for 360 µm OD tubing, 1/32" OD tubing, or our MicroTight Tubing Sleeves (see page 19), these fittings make superior fingertight connections with capillary tubing. MicroTight Fittings withstand temperatures up to 125 °C.

The MicroTight family also includes a female nut matched with one of five dedicated ferrules for connecting specific tubing ODs.

Use the P-277 Extender Tool to tighten standard micro knurl 6-32 fittings in hard-to-reach places. Tighten micro headless 6-32 fittings with our N-290 Tool. See page 33 for more information.

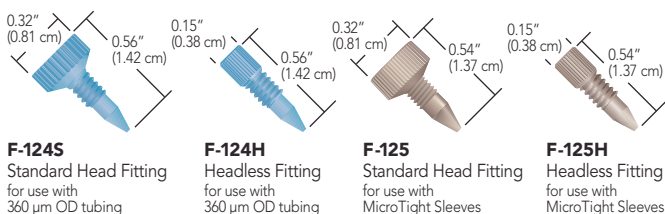

F-124S
Standard Head Fitting
for use with
360 µm OD tubing

F-124H
Headless Fitting
for use with
360 µm OD tubing

F-125
Standard Head Fitting
for use with
MicroTight Sleeves

F-125H
Headless Fitting
for use with
MicroTight Sleeves

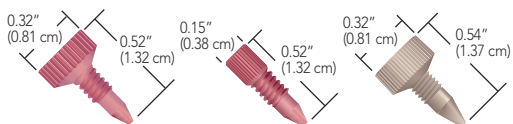

F-126S
Standard Head Fitting
for use with
1/32" OD tubing

F-126H
Headless Fitting
for use with
1/32" OD tubing

P-555
Standard Head Plug

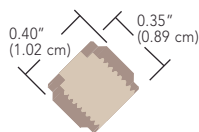

P-416
Female Nut
5/16-24
internal threads



P-416BLK
Female Nut
5/16-24
internal threads



P-416G
Female Nut
5/16-24
internal threads

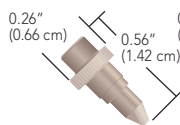

F-112
MicroFerrule
for 1/32" OD tubing

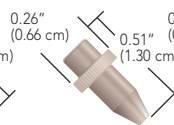

F-132
MicroFerrule
for 1/16" OD tubing

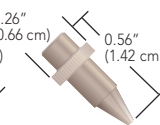

F-152
MicroFerrule
for 360 µm OD tubing

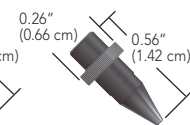

F-172
MicroFerrule
for 0.025" OD tubing

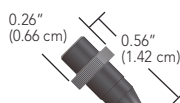

P-116
MicroFerrule Plug

NOTE

MicroTight fittings and MicroFerrules

While the MicroTight Female Nuts may be used with any of the separate MicroFerrules, the MicroFerrules themselves are port-specific and are thus not interchangeable. Additionally, the one-piece MicroTight fittings are also port-specific and should not be exchanged.

RELATED PRODUCTS

- ▶ Connectors for Capillary Tubing can be found on pages 37–45.
- ▶ Very High Pressure fittings for capillary tubing can be found on page 9.
- ▶ Capillary tubing is featured on pages 67.

Part No.	Description	Port	Pressure Rating	Head Style	Material	Qty.
MICROTIGHT FITTINGS						
F-124Hx	MicroTight Fitting for 360 µm OD Tubing	6-32 Coned	5,000 psi (345 bar)	Micro Headless Knurl	PEEK Blue	10-pk
F-124Sx	MicroTight Fitting for 360 µm OD Tubing	6-32 Coned	5,000 psi (345 bar)	Standard Micro Knurl	PEEK Blue	10-pk
F-125Hx	MicroTight Fitting for MicroTight Tubing Sleeves	6-32 Coned	4,000 psi (276 bar)	Micro Headless Knurl	PEEK Natural	10-pk
F-125x	MicroTight Fitting for MicroTight Tubing Sleeves	6-32 Coned	4,000 psi (276 bar)	Standard Micro Knurl	PEEK Natural	10-pk
★ F-126Hx	MicroTight Fitting for 1/32" OD Tubing	6-32 Coned	5,000 psi (345 bar)	Micro Headless Knurl	PEEK Red	10-pk
F-126Sx	MicroTight Fitting for 1/32" OD Tubing	6-32 Coned	5,000 psi (345 bar)	Standard Micro Knurl	PEEK Red	10-pk
P-555	MicroTight Plug	6-32 Coned	5,000 psi (345 bar)	Standard Micro Knurl	PEEK Natural	ea.
MICROFERRULES AND FEMALE NUTS						
F-112	MicroFerrule for 1/32" OD Tubing	5/16-24 Coned	5,000 psi (345 bar)	—	PEEK Natural	ea.
F-132	MicroFerrule for 1/16" OD Tubing	5/16-24 Coned	5,000 psi (345 bar)	—	PEEK Natural	ea.
★ F-152	MicroFerrule for 360 µm OD Tubing	5/16-24 Coned	5,000 psi (345 bar)	—	PEEK Natural	ea.
F-152BLK	MicroFerrule for 360 µm OD Tubing	5/16-24 Coned	5,000 psi (345 bar)	—	PEEK Black	ea.
★ F-172	MicroFerrule for MicroTight Tubing Sleeves	5/16-24 Coned	4,000 psi (276 bar)	—	PEEK Black	ea.
P-116	MicroFerrule Plug	5/16-24 Coned	5,000 psi (345 bar)	—	PEEK Black	ea.
★ P-416	MicroTight Female Nut	5/16-24 Coned	4,000–5,000 psi (276–345 bar)	Female Knurl	PEEK Natural	ea.
P-416BLK	MicroTight Female Nut	5/16-24 Coned	4,000–5,000 psi (276–345 bar)	Female Knurl	PEEK Black	ea.
P-416G	MicroTight Female Nut	5/16-24 Coned	4,000–5,000 psi (276–345 bar)	Female Knurl	PEEK Green	ea.

MicroTight® Tubing Sleeves

- ▶ Manufactured from PEEK polymer
- ▶ Pressure rated to 4,000 psi (276 bar)
- ▶ Color-coded for easy inner diameter identification

Upchurch Scientific® MicroTight Tubing Sleeves feature an outer diameter of 0.025" and offer a wide assortment of inner diameters to help facilitate capillary tubing connections with our MicroTight accessories. Because the sleeves are manufactured from PEEK polymer, they carry an upper temperature threshold of 125 °C.

To use these sleeves properly, choose a sleeve with an inner diameter 0.001"–0.002" (25–50 µm) larger than the outer diameter of your capillary tubing. Then, slip the sleeve over your flow path tubing, such that your tubing extends all the way through the sleeve, but not beyond the end of the sleeve. Choose the correct fitting that corresponds with your receiving port, slide it over the sleeved flow path tubing and connect as normal.



NanoTight™ Tubing Sleeves

- ▶ Manufactured from FEP fluoropolymer
- ▶ Pressure rated to 4,000 psi (276 bar)
- ▶ Outer diameter of 1/16" — the most popular size used on most instrumentation

Upchurch Scientific NanoTight Tubing Sleeves are manufactured using FEP fluoropolymer and precisely cut to a 1.6" length. A wide assortment of sleeves is available, ensuring the availability of a NanoTight sleeve for most applications. Many of the sleeves feature a light color tint that can help more easily identify the inner diameter for future orders. Because FEP is the base polymer for these sleeves, there is a maximum recommended continuous operating temperature of 50 °C.

Upchurch Scientific NanoTight sleeves were designed primarily for use with the NanoTight fittings, found on page 17 and also work well with the Super Flangeless™ fittings for 1/16" OD tubing on pages 21. For tubing sleeves that can be used effectively with stainless steel fittings and at higher temperatures, consider using the Upchurch Scientific PEEK Tubing Sleeves, found on the next page.

APPLICATION NOTE

Why use Sleeves?

Because most capillary tubing connections are made into coned receiving ports, where the port is not designed to be used with capillary tubing directly, special care must be used to ensure a good connection. While custom ferrules can help make these connections, they only offer a fixed-length nose — and because most tubing pockets will vary slightly in length, this can lead to leaking or dead volume.

To help save overall expense while maintaining a concentric connection with minimal dead volume, IDEX Health & Science recommends the use of sleeves. Because sleeves are not permanently attached to a ferrule, they can easily adapt to varying tubing pocket depths. Additionally, because they are manufactured using Upchurch Scientific extruded polymer tubing, you are assured of the concentricity of the resultant connection.

Part No.	ID	For Tubing OD Size	Color	Qty.
MICROTIGHT PEEK TUBING SLEEVES AND KITS, 0.025" OD				
F-180x	125 µm (0.005")	70–110 µm	Red	10-pk
F-181x	180 µm (0.007")	125–165 µm	Yellow	10-pk
F-182x	230 µm (0.009")	175–215 µm	Natural	10-pk
F-183x	280 µm (0.011")	225–265 µm	Blue	10-pk
F-184x	330 µm (0.013")	275–315 µm	Orange	10-pk
★ F-185x	395 µm (0.0155")	340–380 µm	Green	10-pk
F-186x	455 µm (0.018")	400–440 µm	Black	10-pk
F-187x	535 µm (0.021")	480–520 µm	Natural	10-pk
F-188x	152 µm (0.006")	95–135 µm	Purple	10-pk
1328	MicroTight Tubing Sleeve Kit contains (6) each of the sleeve sizes listed above			
1356	MicroTight Connector Kit Kit contains: a 10-pack of each MicroTight Tubing Sleeve (F-180–F-187); (2) P-770 MicroTight Adapters; and (2) MicroTight P-720 Unions			
NANOTIGHT FEP TUBING SLEEVES, 1/16" OD				
F-237x	125 µm (0.005")	70–110 µm	Red	10-pk
F-238x	180 µm (0.007")	125–165 µm	Yellow	10-pk
F-239x	215 µm (0.0085")	160–200 µm	Natural	10-pk
F-240x	280 µm (0.011")	225–265 µm	Blue	10-pk
F-241x	330 µm (0.013")	275–315 µm	Orange	10-pk
★ F-242x	395 µm (0.0155")	340–380 µm	Green	10-pk
F-243x	455 µm (0.018")	400–440 µm	Black	10-pk
F-244x	535 µm (0.021")	480–520 µm	Natural	10-pk
F-245x	610 µm (0.024")	555–595 µm	Red	10-pk
F-246x	685 µm (0.027")	630–670 µm	Yellow	10-pk
F-247x	840 µm (0.033")	785–825 µm	Green	10-pk
F-252x	1.07 mm (0.042")	1 mm	Purple	10-pk

1/16" OD PEEK Tubing Sleeves

- ▶ For connecting capillary tubing to standard 10-32 ports
- ▶ Require the use of wrench tightened stainless steel nuts
- ▶ Pressure rated to 6,000 psi (414 bar)

Like the NanoTight™ FEP Sleeves on the previous page, these PEEK Tubing Sleeves are designed to be used with 1/16" OD, 10-32 threaded fittings to adapt capillary tubing to standard coned ports. Made of PEEK polymer, these 1.3" long sleeves can be used up to 125 °C.

These sleeves require a wrench tightened nut to achieve proper sealing. We recommend the F-140 Two-Piece Fingertight Fitting (page 15), which includes a PEEK ferrule or the hex-head SealTight™ fittings on page 14. Many researchers also use a stainless steel nut and ferrule with these sleeves, such as our U-400 and U-401 (page 10).

1/32" OD PEEK Tubing Sleeves

These 1.6" long Upchurch Scientific® 1/32" OD PEEK Tubing Sleeves can be used with any fitting designed for 1/32" OD tubing when smaller tubing must be connected. Select the appropriate sleeve from the product listing for your capillary tubing OD size. The 1/32" OD PEEK Tubing Sleeves have a maximum recommended temperature of 125 °C and have a pressure rating of 5,000 psi (345 bar).



RELATED PRODUCTS

Use 1/32" OD PEEK or FEP Sleeves to connect capillary tubing with the following:

- ▶ The F-113 Ferrule and Two-Piece Fingertight Fittings for 10-32 ports (page 15).
- ▶ The F-112 and P-416BLK MicroTight® Fittings (page 18) — 1/32" OD PEEK Tubing Sleeves only.
- ▶ The 1/32" OD MicroTight Fittings on page 18.
- ▶ The Rheodyne® RheFlex M4 Fitting (page 12) for MX Module applications; the M-645 Valco®-Compatible Fitting (page 11) for Valco Nanovolume® valve applications.

1/32" OD FEP Tubing Sleeves

These 1.6" long sleeves facilitate connecting capillary tubing into ports designed for 1/32" OD tubing. Please refer to the product listing below to select the appropriate sleeve for your capillary OD size. These sleeves can be used at up to 50 °C and have a pressure rating of 1,750 psi (121 bar).



Clockwise, starting at top:

- ▶ 1/16" OD PEEK Tubing Sleeves, shown with F-140 Fitting
- ▶ 1/32" OD PEEK Tubing Sleeves, shown with F-126H Fitting
- ▶ 1/32" OD FEP Tubing Sleeves, shown with F-126S Fitting
- ▶ Fittings and tubing only shown to highlight how sleeves are designed to be used; they are not included with the sleeves

Part No.	ID	For Tubing OD Size	Color	Qty.
PEEK TUBING SLEEVES FOR 1/16" OD FITTINGS				
F-225	125 µm (0.005")	70–110 µm	Red	ea.
F-226	180 µm (0.007")	125–165 µm	Yellow	ea.
F-227	230 µm (0.009")	175–215 µm	Yellow	ea.
F-228	250 µm (0.011")	225–265 µm	Blue	ea.
F-229	330 µm (0.013")	275–315 µm	Natural	ea.
★ F-230	405 µm (0.016")	350–390 µm	Orange	ea.
F-231	560 µm (0.022")	505–545 µm	Natural	ea.
F-232	785 µm (0.031")	730–770 µm	Natural	ea.
F-233	865 µm (0.034")	785–825 µm	Blue	ea.
F-234	685 µm (0.027")	630–670 µm	Yellow	ea.
PEEK TUBING SLEEVES FOR 1/32" OD FITTINGS				
F-381x	180 µm (0.007")	125–165 µm	Yellow	10-pk
F-382x	205 µm (0.008")	150–190 µm	Natural	10-pk
F-384x	255 µm (0.010")	200–240 µm	Blue	10-pk
★ F-385x	380 µm (0.015")	325–365 µm	Natural	10-pk
F-386x	510 µm (0.020")	455–495 µm	Orange	10-pk
F-387x	250 µm (0.011")	225–265 µm	Red	10-pk
F-388x	330 µm (0.013")	275–315 µm	Black	10-pk
FEP TUBING SLEEVES FOR 1/32" OD FITTINGS				
F-374x	280 µm (0.011")	225–265 µm	Blue	10-pk
F-375x	330 µm (0.013")	275–315 µm	Orange	10-pk
★ F-376x	395 µm (0.0155")	340–380 µm	Green	10-pk

Super Flangeless™ Fittings

- ▶ Highest pressure holding flat-bottom fitting system we offer
- ▶ Eliminates loosening of fittings due to tubing twist
- ▶ Excellent for Tubing Assemblies
- ▶ Holds tight even through vibration

6-40 and 6-32 Options (for 1/16" OD Tubing)

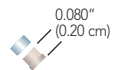

M-650
Super Flangeless Ferrule
for 1/16" OD tubing

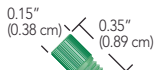

M-644-03
6-40 Nut
shown with M-650 Ferrule
(not included)

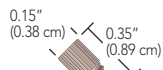

M-660
6-32 Nut
shown with M-650 Ferrule
(not included)

10-32 Options (for 1/16" OD Tubing)



M-250
Super Flangeless Ferrule
for 1/16" OD tubing



M-653
10-32 PEEK
shown with M-250 Ferrule
(not included)

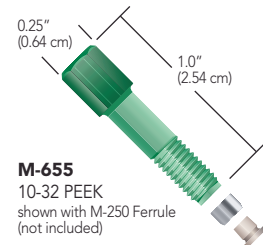

M-655
10-32 PEEK
shown with M-250 Ferrule
(not included)

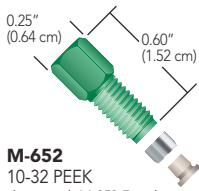

M-652
10-32 PEEK
shown with M-250 Ferrule
(not included)

Ferrules for M6x1, 1/4-28, 5/16-24

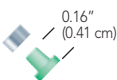

P-248 for 1/32" OD tubing
P-250 for 1/16" OD tubing
P-259 for 1/16" OD tubing

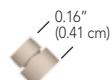

P-260
for 1/16" OD tubing

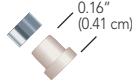

P-350, P-359
for 1/8" OD tubing

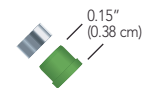

P-355 for 1.8 mm OD tubing
P-366 for 2.5 mm OD tubing
P-352 for 1/8" OD tubing

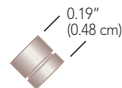

P-360
for 1/8" OD tubing

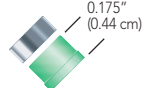

P-140
for 3/16" OD tubing

M6x1, 1/4-28, 5/16-24 Options for 1/32"-3/16" OD Tubing

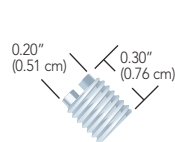

F-356 (1/4-28, $\le 1/16"$ OD Tubing)
F-364 (1/4-28, $> 1/16"$ OD Tubing)

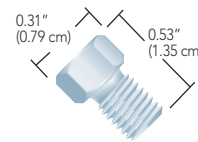

LT-105 (1/4-28, $\le 1/16"$ OD Tubing)
C-235 (1/4-28, $> 1/16"$ OD Tubing)

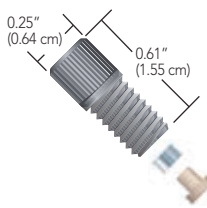

P-213 (M6X1, $\le 1/16"$ OD Tubing)
P-337 (M6X1, $> 1/16"$ OD Tubing)
P-232 (1/4-28, $\le 1/16"$ OD Tubing)
P-336 (1/4-28, $> 1/16"$ OD Tubing)

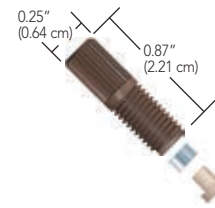

P-287 (1/4-28, $\le 1/16"$ OD Tubing)
P-387 (1/4-28, $> 1/16"$ OD Tubing)

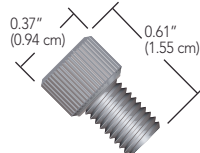

P-219 (M6X1, $\le 1/16"$ OD Tubing)
P-319 (M6X1, $> 1/16"$ OD Tubing)
LT-115 (1/4-28, $\le 1/16"$ OD Tubing)
LT-215 (1/4-28, $> 1/16"$ OD Tubing)

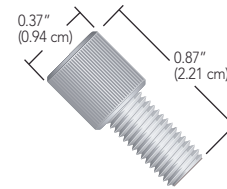

P-217 (M6X1, $\le 1/16"$ OD Tubing)
P-317 (M6X1, $> 1/16"$ OD Tubing)
P-246, P-252, P-255, P-281
(1/4-28, $\le 1/16"$ OD Tubing)
P-331, P-332, P-381
(1/4-28, $> 1/16"$ OD Tubing)

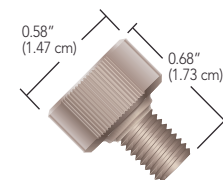

LT-210 (1/4-28, $> 1/16"$ OD Tubing)

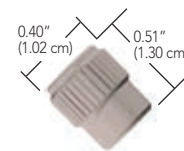

P-420 (1/4-28, $\le 1/16"$ OD Tubing)
F-156 (1/4-28, $> 1/16"$ OD Tubing)

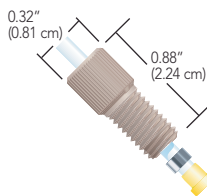

P-141 (5/16-24, $\le 1/16"$ OD Tubing)
P-131 (5/16-24, $> 1/16"$ - $\le 1/8"$ OD Tubing)
P-137 (5/16-24, 3/16" OD Tubing)

Super Flangeless™ Tubing OD / Thread Comparison

	1/32"	1/16"	1.8 mm	2.5 mm	1/8"	3/16"
6-40		•				
6-32		•				
10-32		•				
M6x1	•	•	•	•	•	
1/4-28	•	•	•	•	•	
5/16-24						•

SUPER FLANGELESS FITTINGS SYSTEM

The lock ring allows tightening without twisting the tubing



New One-Piece Super Flangeless Fittings

- ▶ All-PEEK construction
- ▶ For 1/16" OD and 1/8" OD tubing
- ▶ M6x1 and 1/4-28 options
- ▶ Finger tight (2–3 in-lbs / 0.23–0.34 N·m)
- ▶ Extremely easy to use
- ▶ Reusable one piece design that requires no swaging

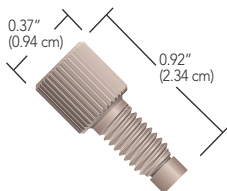

P-329 M6X1, for 1/8" OD Tubing
P-249 1/4-28, for 1/16" OD Tubing
P-349 1/4-28, for 1/8" OD Tubing

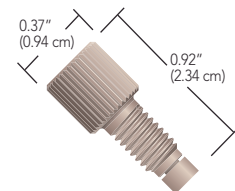

P-229 M6X1, for 1/16" OD Tubing

ASSEMBLY HINT

Make sure the locking ring is oriented correctly! The flattened end of the ring should face towards the nut with the narrow end of the ferrule towards the ring.

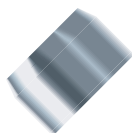

LT-100-02
 Enlarged to show detail

Part No.	Description	Port	Pressure Rating	Head Style	Material	Qty.
SUPER FLANGELESS™ FERRULES FOR 1/32", 1/16", 1/8", 3/16", 1.8MM, 2.0MM, 2.5MM						
M-250x	Super Flangeless Ferrule for 1/16" OD Tubing	10-32 Flat-Bottom	1,000–5,000 psi (69–345 bar)	—	PEEK Natural/SST	10-pk
★ M-650x	Super Flangeless Ferrule for 1/16" OD Tubing	6-32 or 6-40 Flat Bottom	750–3,750 psi (52–259 bar)	—	PEEK Natural/SST	10-pk
P-248x	Super Flangeless Ferrule for 1/32" OD Tubing	10-32 Flat-Bottom	2,500 psi (172 bar)	—	ETFE Green/SST	10-pk
★ P-250x	Super Flangeless Ferrule for 1/16" OD Tubing	1/4-28 or M6 Flat Bottom	2,500 psi (172 bar)	—	PEEK Natural/SST	10-pk
★ P-259x	Super Flangeless Ferrule for 1/16" OD Tubing	1/4-28 or M6 Flat Bottom	1,350 psi (93 bar)	—	ETFE Yellow/SST	10-pk
P-260x	Super Flangeless Ferrule for 1/16" OD Tubing	1/4-28 or M6 Flat Bottom	1,850 psi (128 bar)	—	PEEK Natural/SST	10-pk
★ P-350x	Super Flangeless Ferrule for 1/8" OD Tubing	1/4-28 Flat Bottom	2,500 psi (172 bar)	—	PEEK Natural/SST	10-pk
P-352x	Super Flangeless Ferrule for 1/16" OD Tubing	1/4-28 or M6 Flat Bottom	2,500 psi (172 bar)	—	PEEK Black/SST	10-pk
P-355x	Super Flangeless Ferrule for 1.8 mm OD Tubing	1/4-28 or M6 Flat Bottom	2,500 psi (172 bar)	—	PCTFE Green/SST	10-pk
P-357-2x	Super Flangeless Ferrule for 2.0 mm OD Tubing	M6 Flat Bottom	5,000 psi (345 bar)	—	PEEK Natural/SST	10-pk
★ P-359x	Super Flangeless Ferrule for 1/8" OD Tubing	1/4-28 Flat Bottom	1,000 psi (69 bar)	—	ETFE Yellow/SST	10-pk
P-360x	Super Flangeless Ferrule for 1/8" OD Tubing	1/4-28 Flat Bottom	1,500 psi (102 bar)	—	PEEK Natural/SST	10-pk
NEW! P-366x	Super Flangeless Ferrule for 2.5" OD Tubing	1/4-28 Flat Bottom	1,000 psi (69 bar)	—	PEEK Natural/SST	10-pk
P-140x	Super Flangeless Ferrule for 3/16" OD Tubing	5/16-24 Flat Bottom	500 psi (34 bar)	—	ETFE Green/SST	10-pk
6-40 AND 6-32 FITTINGS FOR 1/16" OD TUBING						
M-660x	Super Flangeless Nut for 1/16" OD Tubing	6-32 Flat Bottom	750–3,750 psi (52–259 bar)	Micro Headless	PEEK Natural	10-pk
★ M-644-03x	Super Flangeless Nut for 1/16" OD Tubing	6-40 Flat Bottom	750–3,750 psi (52–259 bar)	Micro Headless	PEEK Green	10-pk
10-32 FITTINGS FOR 1/16" OD TUBING						
M-652x	Super Flangeless Nut for 1/16" OD Tubing	10-32 Flat Bottom	1,000–5,000 psi (69–345 bar)	1/4" Hex	PEEK Green	10-pk
M-653x	Super Flangeless Nut for 1/16" OD Tubing	10-32 Flat Bottom	1,000–5,000 psi (69–345 bar)	Headless Knurl	PEEK Green	10-pk
M-655x	Super Flangeless Nut for 1/16" OD Tubing, Long	10-32 Flat Bottom	1,000–5,000 psi (69–345 bar)	1/4" Hex	PEEK Green	10-pk
M6X1 FITTINGS FOR 1/16" AND 1/32" OD TUBING						
P-213	Super Flangeless Nut for 1/16" or 1/32" OD Tubing, Short	M6 Flat Bottom	*	Headless Knurl	PEEK Black	ea.
P-217	Super Flangeless Nut for 1/16" or 1/32" OD Tubing	M6 Flat Bottom	*	Standard Knurl	PPS Black	ea.
P-219	Super Flangeless Nut for 1/16" or 1/32" OD Tubing, Short	M6 Flat Bottom	*	Standard Knurl	PEEK Black	ea.
M6X1 FITTINGS FOR 1.8 MM, 2.0 MM, 2.5 MM, 1/8" OD TUBING						
P-317	Super Flangeless For >1/16"–≤ 1/8" OD Tubing	M6 Flat Bottom	*	Standard Knurl	PPS Black	ea.
P-319	Super Flangeless Nut for 1/8" OD Tubing, Short	M6 Flat Bottom	*	Standard Knurl	PEEK Black	ea.
P-337x	Super Flangeless For >1/16"–≤ 1/8" OD Tubing, Short	M6 Flat Bottom	*	Headless Knurl	PEEK Black	10-pk
P-357x	Super Flangeless Fitting for 2.0 mm OD Tubing	M6 Flat Bottom	*	Standard Knurl	PEEK Black, Natural/SST	10-pk
1/4-28 FITTINGS FOR 1/16" AND 1/32" OD TUBING						
F-356x	Super Flangeless Nut for 1/16" or 1/32" OD Tubing, FlushNut	1/4-28 Flat Bottom	*	FlushNut	SST	10-pk
LT-105x	Super Flangeless Nut for 1/16" or 1/32" OD Tubing, Short	1/4-28 Flat Bottom	*	1/4" Hex	SST	10-pk
★ LT-115x	Super Flangeless Nut for 1/16" or 1/32" OD Tubing, Short	1/4-28 Flat Bottom	*	Standard Knurl	PEEK Natural	10-pk
★ P-232	Super Flangeless Nut for 1/16" or 1/32" OD Tubing, Short	1/4-28 Flat Bottom	*	Headless Knurl	PEEK Natural	ea.
P-246x	Super Flangeless Nut for 1/16" or 1/32" OD Tubing	1/4-28 Flat Bottom	*	Standard Knurl	PFA Natural	10-pk
P-252x	Super Flangeless Nut for 1/16" or 1/32" OD Tubing	1/4-28 Flat Bottom	*	Standard Knurl	Delrin® Gray	10-pk
★ P-255x	Super Flangeless Nut for 1/16" or 1/32" OD Tubing	1/4-28 Flat Bottom	*	Standard Knurl	PEEK Natural	10-pk
P-281	Super Flangeless Nut for 1/16" or 1/32" OD Tubing	1/4-28 Flat Bottom	*	Standard Knurl	PPS Natural	ea.
P-287	Super Flangeless Nut for 1/16" or 1/32" OD Tubing	1/4-28 Flat Bottom	*	Headless Knurl	PPS Natural	ea.
P-420	Super Flangeless Nut for 1/16" or 1/32" OD Tubing, Female	1/4-28 Flat Bottom	*	Female Knurl	PEEK Natural	ea.
1/4-28 FITTINGS FOR 1.8MM, 2.5 MM, 1/8" OD TUBING						
C-235x	Super Flangeless Nut for 1/8" OD Tubing	1/4-28 Flat Bottom	*	1/4" Hex	SST	10-pk
F-156	Super Flangeless Nut for 1/8" OD Tubing, Female	1/4-28 Flat Bottom	*	Female Knurl	PEEK Black	ea.
F-364x	Super Flangeless Nut for 1/8" OD Tubing, FlushNut™	1/4-28 Flat Bottom	*	FlushNut	SST	10-pk
LT-210x	Super Flangeless Nut for 1/8" OD Tubing	1/4-28 Flat Bottom	*	Double Wings	PEEK Natural	10-pk
LT-215x	Super Flangeless Nut for 1/8" OD Tubing, Short	1/4-28 Flat Bottom	*	Standard Knurl	PEEK Natural	10-pk
★ P-331	Super Flangeless Nut for 1/8" OD Tubing	1/4-28 Flat Bottom	*	Standard Knurl	PEEK Natural	ea.
P-332x	Super Flangeless Nut for 1/8" OD Tubing	1/4-28 Flat Bottom	*	Standard Knurl	Delrin Black	10-pk
★ P-336	Super Flangeless Nut for 1/8" OD Tubing, Short	1/4-28 Flat Bottom	*	Headless Knurl	PEEK Natural	ea.
★ P-381	Super Flangeless Nut for 1/8" OD Tubing	1/4-28 Flat Bottom	*	Standard Knurl	PPS Natural	ea.
P-387	Super Flangeless Nut for 1/8" OD Tubing	1/4-28 Flat Bottom	*	Standard Knurl	PPS Natural	ea.
5/16-24 FITTINGS FOR 1/16", 1/8", 3/16" OD TUBING						
NEW! P-131x	Super Flangeless Fitting for 1/8" OD Tubing	5/16-24 Flat Bottom	*	Standard Knurl	PEEK Natural	10-pk
NEW! P-137x	Super Flangeless Fitting for 3/16" OD Tubing	5/16-24 Flat Bottom	*	Standard Knurl	PEEK Black	10-pk
NEW! P-141x	Super Flangeless Fitting for 1/16" OD Tubing	5/16-24 Flat Bottom	*	Standard Knurl	PEEK Natural	10-pk
ONE-PIECE SUPER FLANGELESS FITTINGS FOR 1/16" AND 1/8" OD TUBING						
NEW! P-229x	One Piece Super Flangeless Fitting for 1/16" OD Tubing	M6 Flat Bottom	1,000 psi (69 bar)	Standard Knurl	PEEK	10-pk
NEW! P-249x	One Piece Super Flangeless Fitting for 1/16" OD Tubing	1/4-28 Flat Bottom	1,000 psi (69 bar)	Standard Knurl	PEEK	10-pk
NEW! P-329x	One Piece Super Flangeless Fitting for 1/16" OD Tubing	M6 Flat Bottom	1,000 psi (69 bar)	Standard Knurl	PEEK	10-pk
NEW! P-349x	One Piece Super Flangeless Fitting for 1/16" OD Tubing	1/4-28 Flat Bottom	1,000 psi (69 bar)	Standard Knurl	PEEK	10-pk

* Pressure rating of nut depends on the ferrule used.

Flangeless Fittings

Upchurch Scientific® Flangeless Fittings eliminate the need to flange tubing. This removable and reusable system provides several benefits:

Convenience: Flangeless Fittings are easy to use. Just slip the nut and ferrule over the tubing and finger tighten the assembly into your receiving port. In tests, it is shown that the ideal amount of torque to achieve expected part performance should be approximately 3–4 in-lbs (0.34–0.45 N·m). Check out the line of special tightening tools designed to adapt to many standard torque wrenches, on page 33 and the adjustable torque driver, VHP-4000 on page 8.

Minimal Down-Time: Component replacement is quick, taking only a few seconds — unlike the significant time required to flange tubing.

Cost-Effectiveness: Repairing a flanged tubing assembly requires a costly flanging tool or the purchase of a complete replacement assembly, including a new length of tubing and a set of fittings. The Flangeless Fittings system typically requires only one new ferrule at minimal cost when repairing a connection.

The 1/4-28 and M6 Flangeless Fittings for 1/16", 1/8", and metric sized OD tubing are summarized on the following page and listed on pages 25–27.

Ferrules

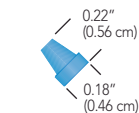

Standard 1/16"
P-200 P-200N

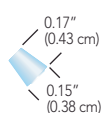

Small Valve 1/16"
P-240

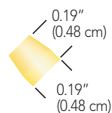

Standard 1/8" and Metric Ferrules
P-300 P-300N P-342
P-353 P-363R P-343

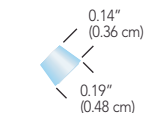

Small Valve 1/8"
P-340

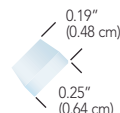

Standard 4.0 mm
P-344

Dimensions for 1/4-28 Flangeless Fittings (pages 24–27)

Nuts

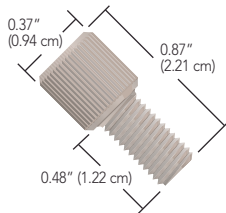

Standard
XP-201 XP-301–XP-305
XP-202 XP-330
XP-220
XP-230
XP-238
XP-245

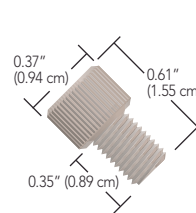

Short
XP-218 P-207S
XP-235 P-247
XP-308 P-307S
XP-335 P-347

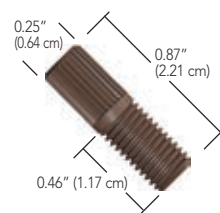

Headless
XP-286 XP-386

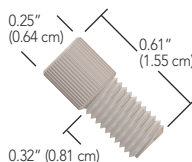

Short Headless
XP-283

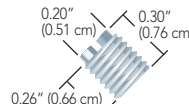

FlushNut™
XF-358 XF-368

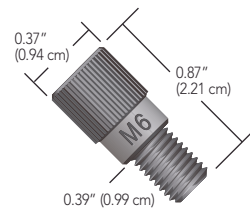

Standard Metric
P-207 P-307

TIP THE CONVENIENCE OF FLANGELESS FITTINGS

Our Flangeless Nuts provide fingertight convenience — no wrenches required.

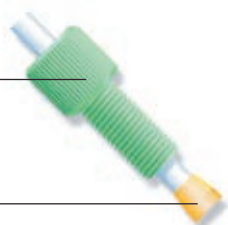

Our Flangeless Ferrules provide a leak-proof seal. There is no need to spend time flanging tubing.

RELATED PRODUCTS

► For the Large Bore Flangeless Fittings, please refer to page 30.

Flangeless Fittings for 1/16" OD Tubing

- ▶ Wide variety of materials and geometries to fit most applications
- ▶ Fittings and ferrules packaged together for easy ordering convenience

The Upchurch Scientific® Flangeless Fittings are excellent replacements for flanged fittings. Flangeless Fittings are dependable, easy to use and easy to replace.

Additionally, all fittings on this page come pre-packaged with appropriate ferrules (1/4-28 threaded fittings are packaged with P-200 ferrules; however, the XLT-111 — a 10-32 threaded fitting — is packaged with P-240 ferrules). Nuts are available in a wide variety of materials, and replacement ferrules are available in ETFE and polypropylene. The designs of many small, low pressure valves incorporate many shallow ports. The P-240 ferrule is designed to seal tightly in such ports and the special sealing ring on this ferrule helps ensure a minimum dead-volume seal between the tubing, ferrule, and port. (Please refer to our website, www.idex-hs.com for polymer chemical compatibility information.)

For higher pressure and temperature applications where a Flangeless connection is desired, consider the Flangeless SealTight™ Fitting System. Both fitting and ferrule are manufactured from PEEK polymer; additionally, the ferrule has been specially engineered to incorporate the dual-compression mechanism of the F-192 SealTight ferrule in a design that allows its use in a 1/4-28 flat-bottom port.

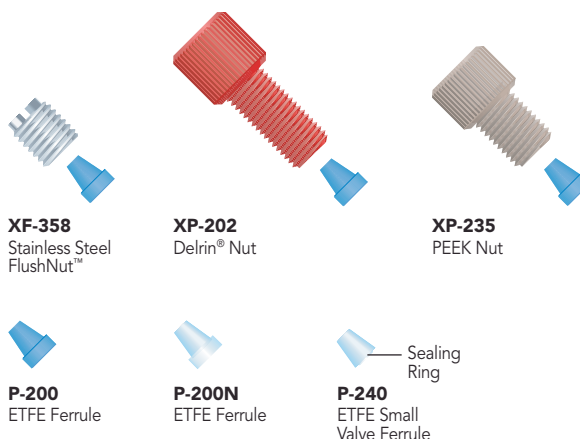

Please see page 24 for the dimensions of the products on this page.

Please Note: The nuts can be ordered separately — simply remove the preceding "X" from the part number to reference the nut separate from the pre-packaged ferrules.

Part No.	Description	Port	Pressure Rating	Head Style	Material	Qty.
FLANGELESS FITTINGS (INCLUDES P-200 FERRULES)						
XF-358x	Flangeless Fitting for 1/16" OD Tubing, FlushNut	1/4-28 Flat-Bottom	2,000 psi (138 bar)	FlushNut	SST/ETFE Blue	10-pk
XLT-111x	Flangeless Fitting for 1/16" OD Tubing	10-32 Flat-Bottom	2,500 psi (172 bar)	Standard Knurl	PEEK Natural/ETFE Natural	10-pk
★ XP-201x	Flangeless Fitting for 1/16" OD Tubing	1/4-28 Flat-Bottom	2,000 psi (138 bar)	Standard Knurl	Delrin Black/ETFE Blue	10-pk
★ XP-202x	Flangeless Fitting for 1/16" OD Tubing	1/4-28 Flat-Bottom	2,000 psi (138 bar)	Standard Knurl	Delrin Red/ETFE Blue	10-pk
★ XP-218x	Flangeless Fitting for 1/16" OD Tubing	1/4-28 Flat-Bottom	2,000 psi (138 bar)	Standard Knurl	ETFE Natural/ETFE Blue	10-pk
★ XP-230x	Flangeless Fitting for 1/16" OD Tubing	1/4-28 Flat-Bottom	2,000 psi (138 bar)	Standard Knurl	PEEK Natural/ETFE Blue	10-pk
★ XP-235x	Flangeless Fitting for 1/16" OD Tubing, Short	1/4-28 Flat-Bottom	2,000 psi (138 bar)	Standard Knurl	PEEK Natural/ETFE Blue	10-pk
★ XP-238x	Flangeless Fitting for 1/16" OD Tubing	1/4-28 Flat-Bottom	2,000 psi (138 bar)	Standard Knurl	Delrin Purple/ETFE Blue	10-pk
★ XP-245x	Flangeless Fitting for 1/16" OD Tubing	1/4-28 Flat-Bottom	2,000 psi (138 bar)	Standard Knurl	PFA Natural/ETFE Blue	10-pk
★ XP-286x	Flangeless Fitting for 1/16" OD Tubing	1/4-28 Flat-Bottom	2,000 psi (138 bar)	Headless Knurl	PPS Natural/ETFE Blue	10-pk
REPLACEMENT FERRULES						
★ P-200x	Flangeless Ferrule for 1/16" OD Tubing	1/4-28 Flat-Bottom	2,000 psi (138 bar)	—	ETFE Blue	10-pk
★ P-200Nx	Flangeless Ferrule for 1/16" OD Tubing	1/4-28 Flat-Bottom	2,000 psi (138 bar)	—	ETFE Natural	10-pk
P-240x	Flangeless Ferrule for 1/16" OD Tubing, Small Valve	1/4-28 or 10-32 Flat-Bottom	2,500 psi (172 bar)	—	ETFE Natural	10-pk

Flangeless Fittings for 1/8" OD Tubing

- ▶ Wide variety of materials and geometries to fit most applications
- ▶ Fittings and ferrules packaged together for easy ordering convenience

Upchurch Scientific® Flangeless Fittings for 1/8" OD tubing feature a wide assortment of nut geometries and materials from which to choose. Fittings shown on this page come in convenient 10-packs and also include P-300 Flangeless Ferrules. (The nuts can be ordered separately — simply remove the preceding "X" from the part number to reference the nut separate from the pre-packaged ferrules.)

All nuts on this page have 1/4-28 threads.

Lock Nut

The P-312 Lock Nut is for use with any 1/4-28 male Flangeless Fitting. Use this product in applications where vibrations can loosen fittings.

To Use: Thread the lock nut onto the male fitting. When the male fitting is firmly seated into the receiving port, tighten the lock nut down against the receiving port to securely hold the male fitting in place.

NOTE

- ▶ The P-340 ferrule is designed for use with shallow receiving ports, such as those used on some low pressure valves.
- ▶ The XF-368 FlushNut is an excellent choice for applications where port-to-port spacing is limited; see page 31 for more information on this innovative product line. As an alternative, consider one of the "headless" fittings shown on this page.



Please see page 24 for the dimensions of the products on this page.

RELATED PRODUCTS

- ▶ Nuts for M6 threaded ports are on page 27; nuts for 5/16-24 threaded ports are on page 30.

Part No.	Description	Port	Pressure Rating	Head Style	Material	Qty.
FLANGELESS FITTINGS (INCLUDES P-300 FERRULES)						
XF-368x	Flangeless Fitting for 1/8" OD Tubing, FlushNut	1/4-28 Flat-Bottom	500 psi (34 bar)	FlushNut	SST/ETFE Yellow	10-pk
★ XP-301x	Flangeless Fitting for 1/8" OD Tubing	1/4-28 Flat-Bottom	500 psi (34 bar)	Standard Knurl	Delrin Black/ETFE Yellow	10-pk
XP-302x	Flangeless Fitting for 1/8" OD Tubing	1/4-28 Flat-Bottom	500 psi (34 bar)	Standard Knurl	Delrin Red/ETFE Yellow	10-pk
XP-305x	Flangeless Fitting for 1/8" OD Tubing	1/4-28 Flat-Bottom	500 psi (34 bar)	Standard Knurl	Delrin Green/ETFE Yellow	10-pk
★ XP-308x	Flangeless Fitting for 1/8" OD Tubing, Short	1/4-28 Flat-Bottom	500 psi (34 bar)	Standard Knurl	Delrin Black/ETFE Yellow	10-pk
XP-315x	Flangeless Fitting for 1/8" OD Tubing	1/4-28 Flat-Bottom	500 psi (34 bar)	Standard Knurl	ETFE Natural/ETFE Yellow	10-pk
★ XP-330x	Flangeless Fitting for 1/8" OD Tubing	1/4-28 Flat-Bottom	500 psi (34 bar)	Standard Knurl	PEEK Natural/ETFE Yellow	10-pk
★ XP-335x	Flangeless Fitting for 1/8" OD Tubing, Short	1/4-28 Flat-Bottom	500 psi (34 bar)	Standard Knurl	PEEK Natural/ETFE Yellow	10-pk
★ XP-386x	Flangeless Fitting for 1/8" OD Tubing	1/4-28 Flat-Bottom	500 psi (34 bar)	Headless Knurl	PPS Natural/ETFE Yellow	10-pk
REPLACEMENT FERRULES						
★ P-300x	Flangeless Ferrule for 1/8" OD Tubing	1/4-28 Flat-Bottom	500 psi (34 bar)	—	ETFE Yellow	10-pk
★ P-300Nx	Flangeless Ferrule for 1/8" OD Tubing	1/4-28 Flat-Bottom	500 psi (34 bar)	—	ETFE Natural	10-pk
★ P-340x	Flangeless Ferrule for 1/8" OD Tubing, Small Valve	1/4-28 Flat-Bottom	500 psi (34 bar)	—	ETFE Natural	10-pk
P-312x	Lock Nut for Flangeless Nuts	1/4-28 Flat-Bottom	—	—	Delrin White	10-pk

Metric Flangeless Fittings

- ▶ For 1/16", 1.8 mm, 2.0 mm, 2.5 mm, 3.0 mm, 4.0 mm, or 1/8" OD tubing
- ▶ Convenience of flangeless fittings for metric tubing sizes and M6 flat-bottom ports

Upchurch Scientific® Metric Flangeless Ferrules are designed to connect 1.8, 2.0, 2.5, 3.0, or 4.0 mm OD tubing to flat-bottom ports when paired with the appropriate M6, 1/4-28, or 5/16-24 Flangeless Nuts. We also offer M6-threaded nuts to connect 1/16" or 1/8" OD tubing, plus a tubing sleeve to facilitate 1.0 mm OD tubing connections. Please refer to the "Metric Connections" chart on this page for information regarding which nuts and ferrules to use with your tubing.



P-342
ETFE Ferrule
for 1.8 OD tubing



P-363R
ETFE Ferrule
for 2.0 mm OD tubing



P-353
ETFE Ferrule
for 2.5 mm OD tubing



P-343
ETFE Ferrule
for 3.0 mm OD tubing



P-344
ETFE Ferrule
for 4.0 mm OD tubing

NEW!



P-207
Delrin® Nut
for 1/16" OD tubing



P-347
PEEK Nut
for 1.8, 2.0, 3.0 mm or
1/8" OD tubing

Please see page 24 for the dimensions of the products on this page.

TIP METRIC CONNECTIONS

Use this chart to determine the low pressure fittings needed to connect metric and English-sized tubing into the indicated ports.

Tubing Size	Port	Ferrules	Nuts
1.0 mm	M6	P-200 (w/F-252 sleeve, not included)	P-207, P-207S, P-247
	1/4-28	P-200 (w/F-252 sleeve, not included)	Any 1/4-28 nut from page 25 ¹
1.8 mm	M6	P-342	P-307, P-307S, P-347
	1/4-28	P-342	Any nut from page 26 ¹
2.0 mm	M6	P-363R	P-307, P-307S, P-347
	1/4-28	P-363R	Any nut from page 26
2.5 mm	M6	P-353	P-307, P-307S, P-347
	1/4-28	P-353	Any nut from page 26 ¹
3.0 mm	M6	P-343	P-307, P-307S, P-347
	1/4-28	P-343	Any nut from page 26 ¹
4.0 mm	5/16-24	P-344	XP-132x from page 30
1/16"	M6	P-200	P-207, P-207S, P-247, P-931, page 28
	M6	P-840	
1/8"	M6	P-300	P-307, P-307S, P-347, P-945, page 28
	M6	P-940	

¹ To order 1/4-28 threaded Flangeless Nuts separately from the Flangeless Ferrules, simply remove the preceding "X" from the appropriate part number — for example, order P-301x instead of XP-301x.

RELATED PRODUCTS

More Metric-Sized Products

	Page
High Pressure Polymer Fittings	9, 12
High Pressure Stainless Steel Fittings	10
Luer Adapters	56
Metric Threaded Adapters	51
External NPT Adapters	52
VacuTight™ Fittings	28
Plugs and Caps	172
Low Pressure Unions	40
Bulkhead Unions	41
PEEK (1.8 mm OD and Capillary) and Fused Silica Tubing	65
PEEKsil™ Tubing	66
FEP Tubing (1.0-4.0 mm OD) and PFA Capillary Tubing	71
Frit-In-A-Ferrule™	166

In addition, many of our 1/4-28 threaded Filters, Valves and Flow Control Accessories can be converted to accept 1.8, 2.0, 2.5 and 3.0 mm tubing, using the ferrules listed for 1/4-28 ports in the "Metric Connections" table, this page.

Part No.	Description	Port	Pressure Rating	Head Style	Material	Qty.
METRIC FLANGELESS NUTS						
P-207x	Flangeless Nut for 1/16" OD Tubing	M6 Flat-Bottom	2,000 psi (138 bar)	Standard Knurl	Delrin Black	10-pk
P-2075x	Flangeless Nut for 1/16" OD Tubing, Short	M6 Flat-Bottom	2,000 psi (138 bar)	Standard Knurl	Delrin Black	10-pk
P-247x	Flangeless Nut for 1/16" OD Tubing, Short	M6 Flat-Bottom	2,000 psi (138 bar)	Standard Knurl	PEEK Black	10-pk
P-307x	Flangeless Nut for 1.8 mm, 2.0 mm, 3.0 mm, 1/8" OD Tubing	M6 Flat-Bottom	500 psi (34 bar)	Standard Knurl	Delrin Black	10-pk
P-3075x	Flangeless Nut for 1.8 mm, 2.0 mm, 3.0 mm, 1/8" OD Tubing	M6 Flat-Bottom	500 psi (34 bar)	Standard Knurl	Delrin Black	10-pk
P-347x	Flangeless Nut for 1.8 mm, 2.0 mm, 3.0 mm, 1/8" OD Tubing	M6 Flat-Bottom	500 psi (34 bar)	Standard Knurl	PEEK Black	10-pk
FLANGELESS FERRULES						
F-252x	1/16" OD Tubing Sleeve for 1.0 mm ID Tubing	M6 or 1/4-28 Flat-Bottom	500 psi (34 bar)	—	FEP Purple	10-pk
★ P-200x	Flangeless Ferrule for 1/16" OD Tubing	M6 or 1/4-28 Flat-Bottom	2,000 psi (138 bar)	—	ETFE Blue	10-pk
★ P-300x	Flangeless Ferrule for 1/8" OD Tubing	M6 or 1/4-28 Flat-Bottom	500 psi (34 bar)	—	ETFE Yellow	10-pk
★ P-342x	Flangeless Ferrule for 1.8 mm OD Tubing	M6 or 1/4-28 Flat-Bottom	500 psi (34 bar)	—	ETFE Green	10-pk
P-343x	Flangeless Ferrule for 3.0 mm OD Tubing	M6 or 1/4-28 Flat-Bottom	500 psi (34 bar)	—	ETFE Orange	10-pk
NEW! P-344x	Flangeless Ferrule for 4.0 mm OD Tubing	5/16-24	250 psi (17 bar)	—	ETFE Natural	10-pk
P-353x	Flangeless Ferrule for 2.5 mm OD Tubing	M6 or 1/4-28 Flat-Bottom	500 psi (34 bar)	—	ETFE Natural	10-pk
P-363Rx	Flangeless Ferrule for 2.0 mm OD Tubing	M6 or 1/4-28 Flat-Bottom	500 psi (34 bar)	—	ETFE Red	10-pk

VacuTight™ Fittings

- ▶ For 1/16" or 1/8" OD tubing connections into 10-32, 1/4-28, or M6 flat-bottom ports
- ▶ Vacuum Rated to 25 in-Hg (84 kPa)
- ▶ Improve transfer volume consistency

Upchurch Scientific® VacuTight Fittings are designed to provide airtight, dependable connections under vacuum and low pressure conditions. Many of the VacuTight Nuts have streamlined profiles for use in systems requiring a large number of connections in a small area. Furthermore, the VacuTight Ferrule's small size ensures sufficient nut/thread engagement, even in shallow ports. These features make VacuTight Fittings ideal for "combichem" high throughput screening, clinical diagnostic, and other automated liquid handling applications.

The configuration of the VacuTight flat-bottom ferrules prevents overcompression and tubing ID reduction that can occur with many coned fittings. The result is more consistent aspirating and dispensing volumes across all system connections.

The VacuTight fittings can also work well in some positive pressure applications. The pressure range for each fitting is listed below and depends upon the tubing used for the connection. Please contact your distributor or IDEX Health & Science for more information. Additionally, please note that some of the VacuTight fittings have changed in color from red to black; however, this color change does not affect product performance.

All VacuTight Nuts must be used exclusively with VacuTight Ferrules.

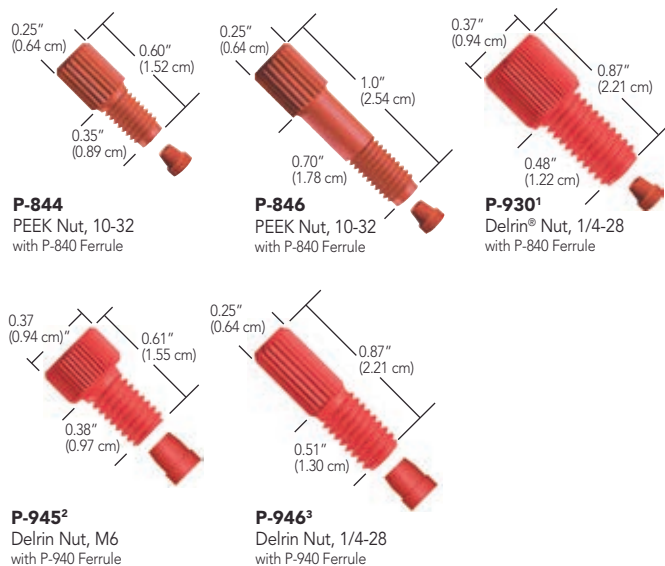

¹ The dimensions shown apply to P-930, P-931, P-938, P-942, and P-948.

² The dimensions shown apply to P-945.

³ The dimensions shown apply to P-946.

Part No.	Description	Port	Pressure Rating	Head Style	Material	Qty.
VACUTIGHT FITTINGS (INCLUDES P-840 OR P-940 FERRULES)						
★ P-842x	VacuTight Fitting for 1/16" OD Tubing, Short	10-32 Flat-Bottom	400–800 psi (27–55 bar)	1/4" Hex	PEEK Red	10-pk
★ P-844x	VacuTight Fitting for 1/16" OD Tubing, Short	10-32 Flat-Bottom	400–800 psi (27–55 bar)	Headless Knurl	PEEK Red	10-pk
P-846x	VacuTight Fitting for 1/16" OD Tubing, Long	10-32 Flat-Bottom	400–800 psi (27–55 bar)	Headless Knurl	PEEK Red	10-pk
P-930x	VacuTight Fitting for 1/16" OD Tubing	1/4-28 Flat-Bottom	400–800 psi (27–55 bar)	Standard Knurl	Delrin Red	10-pk
P-931x	VacuTight Fitting for 1/16" OD Tubing	M6 Flat-Bottom	400–800 psi (27–55 bar)	Standard Knurl	Delrin Red	10-pk
P-938x	VacuTight Fitting for 1/16" OD Tubing	1/4-28 Flat-Bottom	400–800 psi (27–55 bar)	Standard Knurl	PEEK Natural	10-pk
P-942x	VacuTight Fitting for 1/8" OD Tubing	1/4-28 Flat-Bottom	500–1,000 psi (34–69 bar)	Standard Knurl	Delrin Red	10-pk
P-945x	VacuTight Fitting for 1/8" OD Tubing, Short	M6 Flat-Bottom	500–1,000 psi (34–69 bar)	Standard Knurl	Delrin Red	10-pk
P-946x	VacuTight Fitting for 1/8" OD Tubing	1/4-28 Flat-Bottom	500–1,000 psi (34–69 bar)	Headless Knurl	Delrin Red	10-pk
P-948x	VacuTight Fitting for 1/8" OD Tubing	1/4-28 Flat-Bottom	500–1,000 psi (34–69 bar)	Standard Knurl	PEEK Natural	10-pk
REPLACEMENT FERRULES						
P-840x	VacuTight Ferrule for 1/16" OD Tubing	M6 or 1/4-28 Flat-Bottom	400–800 psi (27–55 bar)	—	ETFE Red	10-pk
★ P-940x	VacuTight Ferrule for 1/8" OD Tubing	M6 or 1/4-28 Flat-Bottom	500–1,000 psi (34–69 bar)	—	ETFE Red	10-pk

Flanged Fittings

- ▶ Fittings for 1/16" or 1/8" OD tubing, supplied with nut and 316 stainless steel washer
- ▶ Multiple head styles and materials available
- ▶ For 1/4-28 and M6 flat-bottom ports
- ▶ All head styles, square, hex, and knurl are available in the following colors: black, red, white, green, and blue

Upchurch Scientific® Flanged Fittings are compatible with most standard 1/4-28 or M6 Flat-Bottom flanged fittings. The hard, inert Delrin® (acetal resin) nut resists cross threading or loosening during use, while the ETFE nuts work well in chemically aggressive environments.

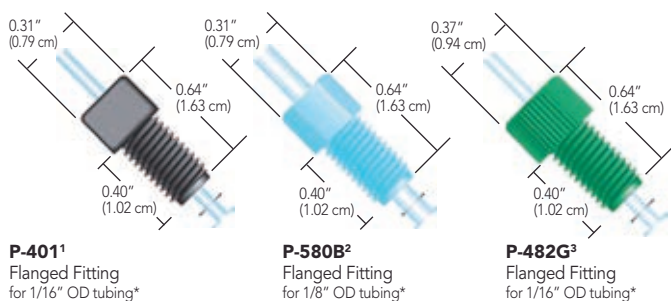

- 1 The dimensions shown apply to all square-head Flanged Fittings
 2 The dimensions shown apply to all hex-head Flanged Fittings
 3 The dimensions shown apply to all knurled-head Flanged Fittings
 * Flanged tubing not included

RELATED PRODUCTS

- ▶ For an alternative to flanging tubing, we highly recommend the Flangeless Fittings found on pages 24–27, the Super Flangeless™ Fittings found on pages 21–23, or the VacuTight™ Fittings on page 28.

Part No.	Description	Port Geometry	Head Style	Material (Nut/Washer)	Qty.
FLANGED FITTINGS (INCLUDES STAINLESS STEEL WASHERS)					
P-401x	Flanged Fitting for 1/16" OD Tubing	1/4-28 Flat-Bottom	5/16" Square	Delrin Black/SST	10-pk
★ P-480BLK	Flanged Fitting for 1/16" OD Tubing	1/4-28 Flat-Bottom	5/16" Hex	Delrin Black/SST	ea.
P-482BLK	Flanged Fitting for 1/16" OD Tubing	1/4-28 Flat-Bottom	Standard Knurl	Delrin Black/SST	ea.
P-501x	Flanged Fitting for 1/8" OD Tubing	1/4-28 Flat-Bottom	5/16" Square	Delrin Black/SST	10-pk
P-580BLK	Flanged Fitting for 1/8" OD Tubing	1/4-28 Flat-Bottom	5/16" Hex	Delrin Black/SST	ea.
P-582BLK	Flanged Fitting for 1/8" OD Tubing	1/4-28 Flat-Bottom	Standard Knurl	Delrin Black/SST	ea.
P-982BLKx	Flanged Fitting for 1/16" OD Tubing	M6 Flat-Bottom	Standard Knurl	Delrin Black/SST	10-pk
P-1082BLKx	Flanged Fitting for 1/8" OD Tubing	M6 Flat-Bottom	Standard Knurl	Delrin Black/SST	10-pk
REPLACEMENT WASHERS					
P-407x	Washer for 1/16" OD Tubing	1/4-28 Flat-Bottom	—	SST	10-pk
P-507x	Washer for 1/8" OD Tubing	1/4-28 Flat-Bottom	—	SST	10-pk
P-987x	Washer for 1/16" OD Tubing	M6 Flat-Bottom	—	SST	10-pk
P-1087x	Washer for 1/8" OD Tubing	M6 Flat-Bottom	—	SST	10-pk

Large Bore Fittings

- ▶ 5/16-24 or 1/2-20 threads
- ▶ For use with 1/16", 1/8", 3/16", 1/4", 5/16", 3.0 mm, or 4.0 mm OD tubing

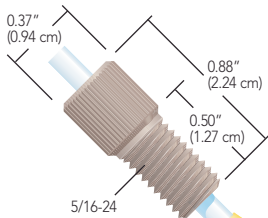

XP-130
PEEK Nut,
for 1/8" OD tubing
shown with P-300 Flangeless Ferrule
(page 26)

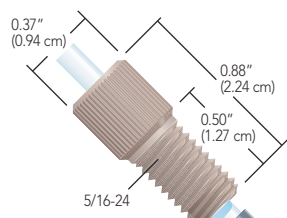

XP-131
PEEK Nut,
for 1/8" OD tubing
shown with P-359 Super Flangeless™
Ferrule (included and found on page 23)

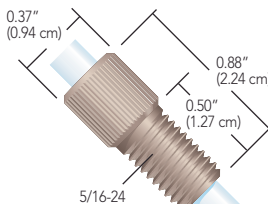

XP-132
PEEK Nut, for 3/16" and
4.0 mm OD tubing
shown with P-133 Flangeless Ferrule
(included and found on this page)

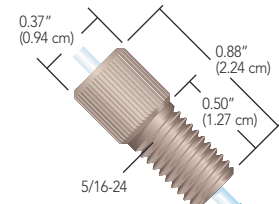

XP-136
PEEK Nut,
for 1/16" OD tubing
shown with P-200 Flangeless Ferrule
(included and found on page 25)

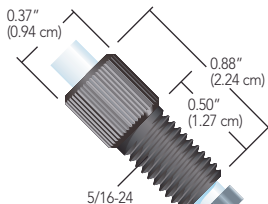

XP-137
PEEK Nut,
for 3/16" OD tubing
shown with P-140 Super Flangeless Ferrule
(included and found on this page)

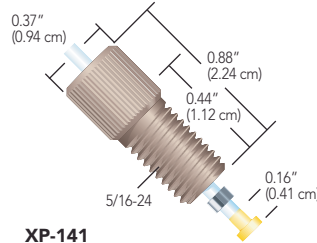

XP-141
PEEK Nut,
for 1/16" OD tubing
shown with P-259 Super Flangeless Ferrule
(included and found on page 23)

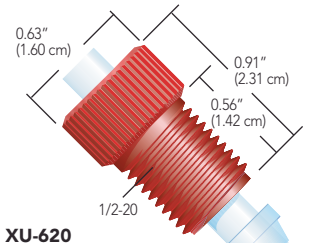

XU-620
PEEK Nut,
for 1/4" OD tubing
shown with inverted U-650 Flangeless
Ferrule for coned ports
(included and found on this page)

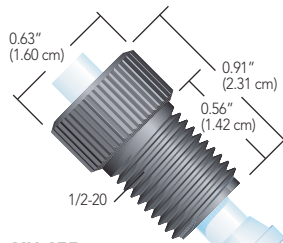

XU-655
PEEK Nut,
for 1/4" OD tubing
shown with U-650 Flangeless Ferrule
(included and found on this page)

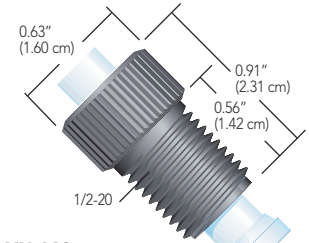

XU-662
PEEK Nut,
for 5/16" OD tubing
shown with U-660 Flangeless Ferrule
(included and found on this page)

Please Note: Each of the Large Bore Fittings shown on this page comes in a convenient 10-pack and is packaged with the most popularly chosen Ferrule option. The Fittings can be ordered separately by removing the preceding letter "X" from the part number. Additionally, to connect metric-sized tubing with outer diameters less than 4.0 mm to 5/16-24 threaded ports, reference the chart on page 27 to choose the correct nut/ferrule combination.

RELATED PRODUCTS

More Large Bore Products

	Page		Page
5/16-24 Coned Fittings	18	FEP, PFA Tubing	71, 72
Barbed Adapters	58	Tubing Cutter	74
Threaded Adapters	48	Pressure Relief Valve	154
Plugs	32, 159	Solvent Inlet Filters	157
Y Connector	47	Bottle Caps	159
ETFE Tubing	73	Semi-Prep Inline Filters	161

Part No.	Description	Port	Pressure Rating	Head Style	Material (Nut/Washer)	Qty.
LARGE BORE FITTINGS						
XP-130x	Flangeless Fitting for 1/8" OD tubing	5/16-24 Flat-Bottom	500 psi (34 bar)	Standard Knurl	PEEK Natural/ETFE Yellow	10-pk
XP-131x	Super Flangeless Fitting for 1/8" OD tubing	5/16-24 Flat-Bottom	1,000 psi (69 bar)	Standard Knurl	PEEK Natural/ETFE Yellow/SST	10-pk
★ XP-132x	Flangeless Fitting for 3/16" OD tubing	5/16-24 Flat-Bottom	500 psi (34 bar)	Standard Knurl	PEEK Natural/ETFE Blue	10-pk
XP-136x	Flangeless Fitting for 1/16" OD tubing	5/16-24 Flat-Bottom	2,000 psi (138 bar)	Standard Knurl	PEEK Natural/ETFE Blue	10-pk
XP-137x	Super Flangeless Fitting for 3/16" OD tubing	5/16-24 Flat-Bottom	500 psi (34 bar)	Standard Knurl	PEEK Black/ETFE Green/SST	10-pk
XP-141x	Super Flangeless Fitting for 1/16" OD tubing	5/16-24 Flat-Bottom	1,350 psi (93 bar)	Standard Knurl	PEEK Natural/ETFE Yellow/SST	10-pk
XP-143x	Flangeless Fitting for 3.0 mm OD tubing	5/16-24 Flat-Bottom	500 psi (34 bar)	Standard Knurl	PEEK Natural/ETFE Orange	10-pk
XU-620x	Flangeless Fitting for 1/4" OD tubing	1/2-20 Coned	250 psi (17 bar)	Large Knurl	PEEK Red/ETFE Natural	10-pk
XU-655x	Flangeless Fitting for 1/4" OD tubing	1/2-20 Flat-Bottom	250 psi (17 bar)	Large Knurl	PEEK Black/ETFE Natural	10-pk
XU-662x	Flangeless Fitting for 5/16" OD tubing	1/2-20 Flat-Bottom	250 psi (17 bar)	Large Knurl	PEEK Black/ETFE Natural	10-pk
REPLACEMENT FERRULES						
★ P-133x	Flangeless Ferrule for 3/16" OD tubing	5/16-24 Flat-Bottom	500 psi (34 bar)	—	ETFE Blue	10-pk
P-133Nx	Flangeless Ferrule for 3/16" OD tubing	5/16-24 Flat-Bottom	500 psi (34 bar)	—	ETFE Natural	10-pk
P-140x	Super Flangeless Ferrule for 3/16" OD tubing	5/16-24 Flat-Bottom	500 psi (34 bar)	—	ETFE Green	10-pk
U-650x	Flangeless Ferrule for 1/4" OD tubing	1/2-20 Flat-Bottom	250 psi (17 bar)	—	ETFE Natural	10-pk
U-660x	Flangeless Ferrule for 5/16" OD tubing	1/2-20 Flat-Bottom	250 psi (17 bar)	—	ETFE Natural	10-pk

FlushNut™ Fittings

- ▶ Tightens flush with the top of the receiving port
- ▶ Several ferrule options

Upchurch Scientific® FlushNut Fittings are designed for those tight-space applications where nut heads often interfere with each other. When coupled with an appropriate ferrule and tightened into a receiving port, the FlushNut's slotted head seats at or near flush with the top of the port. This feature allows FlushNut Fittings to reside in closer proximity than any other option on the market. All FlushNut Fittings are manufactured from 316 stainless steel, except the P-321 Plug, which is made of PEEK polymer.

Tighten or remove FlushNut Fittings with our specially designed FlushNut Wrenches, available in 10-32 or 1/4-28 versions. For more information on the FlushNut wrenches, see page 33.

FlushNut Fittings System

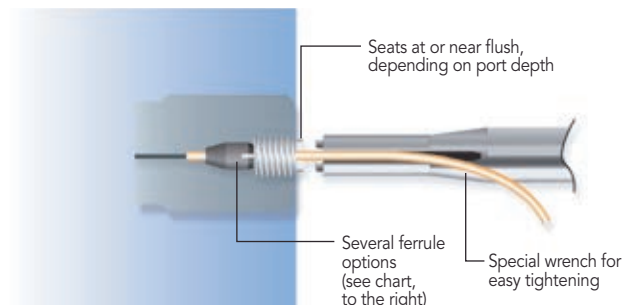

Lee Company "MINSTAC®" Compatible Fittings

- ▶ Super Flangeless™ style ferrules designed specifically to work with 6-40 nuts in Lee MINSTAC valve ports
- ▶ For 1/16" OD tubing

Upchurch Scientific TinyTight™ Fittings are easy-to-use alternatives for Lee Company 062 MINSTAC fittings systems. These fittings consist of a TinyTight Ferrule which works with the 6-40 threaded nut on this page, M-644-03. Choose from two ferrule options, with 0.020" (0.50 mm) or 0.030" (0.75 mm) thru-holes. To use, simply slide a fitting head-first onto your tubing, followed by the ring and ferrule, and thread this assembly into the solenoid valve receiving port, while making sure the tubing is bottomed out. No collets, colletting tools, or chamfering tools required; however, if needed for easier assembly of the TinyTight fittings, the M-150 tool is available. To use, first place the tool in a vise, then tighten tubing, fitting, and ferrule into the tool as you would into any port. Once removed, the swaged ferrule will be held in place on the tubing.

The TinyTight fittings have a pressure range that depends upon the tubing used for the connection. Please contact your distributor or IDEX Health & Science for more information.



M-644-03
Headless Nut
6-40 threads



M-647
TinyTight Ferrule
for 1/16" OD tubing
0.020" thru-hole



M-657
TinyTight Ferrule
for 1/16" OD tubing
0.030" thru-hole

RELATED PRODUCTS

FlushNut Ferrule Options

FlushNut	Threads/ Port*	For Tubing OD	Ferrule Options	Page
F-350	10-32 C	1/16"	SealTight™ F-192	14
F-354	10-32 C	1/32"	LiteTouch® LT-132	16
		1/16"	LiteTouch LT-100	16
		1/16"	LiteTouch SealTight LT-135	16
F-364	1/4-28 C	1/8"	LiteTouch LT-200	16
		1/8"	Super Flangeless P-350, P-352, P-359, P-360	23
		2.0 mm	Super Flangeless P-355	23
F-356	1/4-28 FB	1/32"	Super Flangeless P-248	23
		1/16"	Super Flangeless P-250, P-259, P-260	23
		1/16"	Flangeless P-200, P-200N, P-240	24
XF-358	1/4-28 FB	1/8"	Flangeless P-300, P-300N, P-340	24
		1.8 mm	Flangeless P-342	24
XF-368	1/4-28 FB	2.0 mm	Flangeless P-363R	24
		2.5 mm	Flangeless P-353	24
		3.0 mm	Flangeless P-343	24
P-321	1/4-28 FB	N/A	Plug — No ferrule required	32

* C=Coned; FB=Flat-bottom

To order FlushNuts separately from the included ferrules, simply remove the preceding "X" from the appropriate part number — for example, order F-358 instead of XF-358.

Part No.	Description	Port	Pressure Rating	Head Style	Material	Qty.
TINYTIGHT FITTINGS						
M-150	Swaging Tool for TinyTight Fittings	6-40 MINSTAC	—	—	SST	ea.
M-644-03x	Super Flangeless Nut for 1/16" OD Tubing	6-40 Flat Bottom or MINSTAC	750–3,750 psi (52–259 bar)	Micro Headless	PEEK Green	10-pk
M-647x	TinyTight Ferrule for 1/16" OD Tubing, 0.020" Thru-Hole	6-40 MINSTAC	750–3,750 psi (52–259 bar)	—	PEEK Natural/SST	10-pk
★ M-657x	TinyTight Ferrule for 1/16" OD Tubing, 0.030" Thru-Hole	6-40 MINSTAC	750–3,750 psi (52–259 bar)	—	PEEK Natural/SST	10-pk

Plugs & Caps

- Seal 6-32, 6-40, 10-32, 1/4-28, M6, or 5/16-24 threaded ports or fittings

Use Upchurch Scientific® plugs to close off unused ports in valves and multi-port connectors. Our color-coded 10-32 threaded plugs are perfect for identifying stored columns that have different packing materials, or in which different mobile phases have been utilized. Cap off tubing with one of the PEEK or ETFE caps presented on this page and the appropriate fittings from this chapter.

To help determine which plug or cap is best suited for your application, please visit www.idex-hs.com for detailed chemical compatibility data.

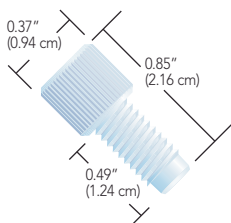

P-316
PFA Plug
for 1/4-28 flat-bottom ports

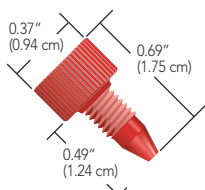

U-467R
Delrin® Column Plug
for 10-32 coned ports

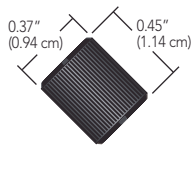

P-755
ETFE Cap
for 1/4-28 flat-bottom fittings

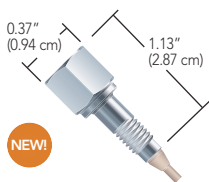

VHP-600
VHP Plug
for 10-32 coned ports

Part No.	Description	Head Style	Material	Qty.
PLUGS				
P-120	Plug for 1/4-28 Coned Ports for 1/8" OD Tubing	Standard Knurl	PCTFE Natural	ea.
P-123	Plug for 1/4-28 Flat-Bottom Ports	5/16" Hex	ETFE Natural	ea.
★ P-309x	Plug for 1/4-28 Flat-Bottom Ports	Standard Knurl	Delrin Black	10-pk
★ P-311	Plug for 1/4-28 Flat-Bottom Ports	Standard Knurl	ETFE Natural	ea.
P-314	Plug for M6 Flat-Bottom Ports	Standard Knurl	ETFE Black	ea.
★ P-316	Plug for 1/4-28 Flat-Bottom Ports	Standard Knurl	PFA Natural	ea.
P-321	Plug for 1/4-28 Flat-Bottom Ports, FlushNut™	FlushNut	PEEK Natural	ea.
P-520	Plug for 10-32 Coned Ports	5/16" Hex	SST	ea.
P-550	Plug for 10-32 Coned Ports, Extra Long	Standard Knurl	PEEK Natural	ea.
★ P-551	Plug for 10-32 Coned Ports	Standard Knurl	PEEK Natural	ea.
P-552	Plug for 6-40 Coned Ports	Headless Knurl	PEEK Natural/PCTFE	ea.
P-555	Plug for 6-32 Coned Ports	Standard Micro Knurl	PEEK Natural	ea.
P-556	Plug for 5/16-24 Flat-Bottom Ports	Standard Knurl	PEEK Natural	ea.
P-558	Plug for 6-40 Flat-Bottom Ports	Micro Headless Knurl	PEEK Green	ea.
P-559	Plug for 6-32 Flat-Bottom Ports	Micro Headless Knurl	PEEK Natural	ea.
P-849	Plug for 10-32 Flat-Bottom Ports	Standard Knurl	Delrin Black	ea.
U-467Rx	Plug for 10-32 Coned Ports	Standard Knurl	Delrin Red	10-pk
NEW! VHP-600	VHP Plug for 10-32 Coned Ports	3/8" Hex	PK-SST	ea.
CAPS				
P-754	Cap for 10-32 Coned Ports	Standard Knurl	ETFE Yellow	ea.
★ P-755	Cap for 1/4-28 Flat-Bottom Ports	Standard Knurl	ETFE Black	ea.
P-756	Cap for M6 Flat-Bottom Ports	Standard Knurl	ETFE Blue	ea.

Extender Tools

These tools can be used to tighten most of our knurled nuts in hard to reach places. See the application note on this page for knurl size and corresponding extender tool.

For precise tightening, the extender tools listed with 1/4" hex drives are designed to adapt to any torque wrench with a female 1/4" socket, such as the VHP-4000 Torque Driver on page 8. The tools featured on this page also include the FlushNut™ wrenches, used to tighten the FlushNuts found throughout this chapter and described in detail on page 31.



Removal Tool

Use the LT-300 Removal Tool to detach LiteTouch® and Super Flangeless™ Ferrules from tubing. Simply slide the appropriate tool blade slot between the lock ring and the ferrule body. With a slight twist, the ring will pop off, releasing the ferrule from the tubing. *Please Note: This Removal Tool will not work with the LT-135 Ferrule System.*



Wrenches

For your convenience, we offer wrenches in three standard sizes. You will need two A-304 wrenches to tighten most nuts into unions found on page 36 (for union 1593, you need one A-304 and one A-320 wrench).



The IDEX Wrench is slotted to fit over 1/16" and 1/8" OD tubing, and has 1/4" and 5/16" internal hex ends, to engage with the heads of the hex-head fittings most commonly used with Rheodyne® valves and the stainless steel fittings listed on page 10.

APPLICATION NOTE

The drawings represent actual size of the various knurled head designs of the Upchurch Scientific® nuts featured in this chapter. Select the appropriate extender tool for the knurl pattern of the nut you've selected.

Female Knurl	Standard Knurl	Headless Knurl
Standard Micro Knurl	Micro Headless Knurl	

Part No.	Description	Material	Qty.
EXTENDER TOOLS			
P-291	Extender Tool for Standard Head Nuts, with 1/4" Hex Drive	Aluminum	ea.
P-298	Extender Tool for Standard Head Nuts	Delrin®	ea.
P-299	Extender Tool for Standard Head Nuts	Aluminum	ea.
P-399	Extender Tool for Standard Head Nuts, Short	Aluminum	ea.
P-297	Extender Tool for Headless Nuts	Aluminum	ea.
P-292	Extender Tool for Headless Nuts, with 1/4" Hex Drive	Aluminum	ea.
P-277	Extender Tool for Standard Micro Nuts	Aluminum	ea.
N-290	Extender Tool for Micro Headless Nuts	Aluminum	ea.
P-278	Extender Tool for Female Nuts, with 1/4" Hex Drive	Aluminum	ea.
MISCELLANEOUS TOOLS			
A-304	Wrench, 1/4" x 5/16"	Steel	ea.
A-305	Wrench, 1/2" x 9/16"	Steel	ea.
A-320	Wrench, 3/8" x 7/16"	Steel	ea.
6810	IDEX Wrench, 1/4" x 5/16"	Steel	ea.
F-345	FlushNut Wrench for 10-32 Threaded Fittings	Steel/Plastic Handle	ea.
F-346	FlushNut Wrench for 1/4-28 Threaded Fittings	Steel/Plastic Handle	ea.
LT-300	Removal Tool for LiteTouch and Super Flangeless Ferrules	Steel/Plastic Handle	ea.