

# CONNECTORS

## VHP UNIONS

PAGE 36

## LOW PRESSURE UNIONS

PAGE 40

## THREADED ADAPTERS

PAGE 48

## BARBED ADAPTERS

PAGE 58



## How to Order

### Direct from IDEX Health & Science

#### For North America orders:

**Tel:** +1 800 426 0191 / +1 360 679 2528

**Fax:** +1 800 359 3460 / +1 360 679 3830

**E-mail:** CustomerService.hs@idexcorp.com

#### For Europe orders:

**Tel:** +49 (0) 1801 808 800

**Fax:** +49 (0) 9377 1388

**E-mail:** CustomerService.hsEurope@idexcorp.com

#### For Asia orders:

**E-mail:** CustomerService.hsAsia@idexcorp.com

#### NORTH ASIA

**Tel:** +86 10 6566 9090 / +86 21 5241 5599

**Fax:** +86 10 6567 5152 / +86 21 5241 8338

#### SOUTHEAST ASIA AND OCEANIA

**Tel:** +65 6684 7307

**Fax:** +65 6795 8070

#### SOUTH ASIA

**Tel:** +91 22 66 78 55 50

**Fax:** +91 22 66 78 00 55

#### JAPAN

**Tel:** +81 48 240 5750

**Fax:** +81 48 259 0715

#### For Online orders:

**Web:** www.idex-hs.com

Please include the following information with your order: Purchase Order Number, Contact Name, Shipping and Billing Address, Telephone Number, Product Number(s) and Quantity(ies). If you are a Purchasing Agent, please include the name of the person for whom the products are ordered.

For your information, our U.S. Federal Taxpayer Identification number is 01-0736657; European Taxpayer Identification number is DE 146581180.

### Order Processing/Shipping

Orders process within one business day and ship within two business days. Requests for earlier shipments can be made — please contact IDEX Health & Science for more details.

All shipments are FCA unless otherwise noted. Shipping charges will be prepaid and added to the invoice. Or, if requested, we will charge your carrier account number.

### Terms

Terms of payment are net 30 days. **Credit cards are accepted for orders placed directly with our U.S. site. No international credit card payment is possible.** Customers are responsible for C.O.D. charges if they elect this payment method. Terms and prices are subject to change without notice. Visit [www.idex-hs.com](http://www.idex-hs.com) for complete Terms & Conditions.

### Return of Materials

Returns must be authorized in advance. Please contact us within 30 days of purchase for your Returns Material Authorization (RMA) Number. A restocking fee may apply.



Customer Number:

## Direct from our Global Distribution Network

The IDEX Health & Science brands represented in this catalog (Ismatec®, Isolation Technologies™, Rheodyne®, Systec®, and Upchurch Scientific®) have established relationships with a large, global network of Distributors, many of whom can offer the product support and assistance that we cannot, including:

- ▶ Carrying local inventory of commonly-ordered items
- ▶ Understanding YOUR working environment and requirements
- ▶ Providing technical application assistance
- ▶ Answering questions regarding new and existing products
- ▶ Complete availability during your time zone business hours
- ▶ Personal visits as required
- ▶ Access to complementary product lines to provide a "one-stop shopping" experience

We have come to rely on our authorized Distributors to provide value-added service to end-users of our products. So, while we are happy to take your order directly, we encourage you to contact your local Distributor — we feel confident it will be a positive experience!

### How to Find A Local Distributor

For a complete distributor listing please visit [www.idex-hs.com/distributors](http://www.idex-hs.com/distributors) or email:

**US:** CustomerService.hs@idexcorp.com

**Europe:** CustomerService.hsEurope@idexcorp.com

**Asia:** CustomerService.hsAsia@idexcorp.com

Our customer service team will help you contact a distributor in your area.

### Return of Materials

Product purchased through a Distributor must be returned directly to that Distributor. Please contact them for Return Material Authorization procedures.

*The products in this catalog are intended for use with analytical, biotechnology and diagnostic equipment and accessories. THE MANUFACTURERS OF THE PRODUCTS IN THIS CATALOG SHALL HAVE NO LIABILITY WHATSOEVER DUE TO ANY MISUSE OF THEIR PRODUCTS. Of course, the safe use of our products depends on our customers, since it is you who select and control the protective gear and safety procedures used, as well as the pressures, temperatures, solvents, samples, ventilation, and other variables. Product and material performance ratings are provided as guides only. Individual field tests should be performed by customers to determine safe operating parameters given your particular procedures and use.*

IDEX Health & Science facilities are certified ISO 9001. Some facilities are also certified ISO 13485:2003.



Visit us online!  
[www.idex-hs.com](http://www.idex-hs.com)

## Connectors Reference Chart

This chart offers suggestions for connecting two pieces of inline tubing. The required product numbers are listed, with the appropriate page numbers listed below them in respective order. In most cases other options exist. For more information, please contact IDEX Health & Science or your local distributor.

TUBING SIZE (OD)	CAPILLARY (<1/32" OD)	1/32"	1 mm	1/16"	1.8–3 mm	1/8"	4 mm, 3/16"	1/4"	5/16"
<b>CAPILLARY (&lt;1/32" OD)</b>	P-720 + MTSlv or P-882 or P-772 or P-779 + (2) NTSlv Pages: 39, 19, 52, 39, 38, 19	P-779 + NTSlv + F-247 Pages: 38, 19	P-779 + NTSlv + F-252 Pages: 38, 19	P-770 + MTSlv Pages: 38, 19	P-627 + NTSys + MFF + XP-335 Pages: 48, 19, 27, 26	P-627 + NTSys + XP-335 Pages: 49, 19, 26	P-135 + P-259 + NTSys + LT-115 + LBFF + XP-132 Pages: 48, 23, 19, 23, 30	U-665 + P-259 + NTSlv + LT-115 Pages: 48, 23, 19, 23	U-665 + XU-662 + P-259 + NTSlv + LT-115 Pages: 48, 30, 60, 19, 23
<b>1/32"</b>	P-779 + NTSlv + F-247 Pages: 38, 19	P-771 Page: 39	P-779 + F-247 + F-252 Pages: 38, 19, 19	P-881 Page: 52	P-702 + P-248 + LT-115 + MFF + XP-335 Pages: 40, 23, 23, 27, 26	P-702 + P-248 + LT-115 + XP-335 Pages: 40, 23, 23, 26	P-135 + P-248 + LT-115 + LBFF + XP-132 Pages: 48, 23, 23, 30, 30	U-665 + P-248 + LT-115 Pages: 48, 23, 23	U-665 + XU-662 + P-248 + LT-115 Pages: 48, 30, 23, 23
<b>1 mm</b>	P-779 + NTSlv + F-252 Pages: 38, 19	P-779 + F-247 + F-252 Pages: 38, 19, 19	P-779+ (2) F-252 Pages: 38, 19	P-779 + F-252 Pages: 38, 19	P-702 + F-252 + MFF + XP-335 Pages: 40, 19, 27, 26	P-702 + F-252 + XP-335 Pages: 40, 19, 26	P-135 + XP-235 + F-252 + LBFF + XP-132 Pages: 48, 25, 19, 27, 30	U-665 + XP-235 + F-252 Pages: 48, 25, 19	U-665 + XU-662 + XP-235 + F-252 Pages: 48, 30, 25, 19
<b>1/16"</b>	P-770 + MTSlv Pages: 38, 19	P-881 Page: 52	P-779 + F-252 Pages: 38, 19	P-742 or P-702 Pages: 38, 40	P-702 + MFF + XP-335 Pages: 40, 27, 26	P-703 + XP-235 Pages: 40, 25	P-135 + XP-235 + LBFF + XP-132 Pages: 48, 25, 30, 30	U-665 + XP-235 Pages: 49, 25	U-665 + XU-662 + XP-235 Pages: 48, 30, 25
<b>1.8–3 mm</b>	P-627 + NTSys + MFF + XP-335 Pages: 48, 19, 27, 26	P-702 + P-248 + LT-115 + MFF + XP-335 Pages: 40, 23, 23, 27, 26	P-702 + F-252 + MFF + XP-335 Pages: 40, 19, 27, 26	P-702 + MFF + XP-335 Pages: 40, 27, 26	P-703 + (2) MFF Pages: 40, 27	P-703 + MFF Pages: 40, 27	P-135 + XP-335 + LBFF + XP-132 Pages: 48, 27, 26, 30	U-665 + MFF + XP-335 Pages: 48, 27, 26	U-665 + XU-662 + MFF + XP-335 Pages: 48, 30, 27, 26
<b>1/8"</b>	P-627 + NTSys + XP-335 Pages: 48, 19, 26	P-702 + P-248 + LT-115 + XP-335 Pages: 40, 23, 23, 26	P-702 + F-252 + XP-335 Pages: 40, 19, 26	P-703 + XP-235 Pages: 40, 25	P-703 + MFF Pages: 40, 27	P-703 Page: 40	P-135 + XP-335 + LBFF + XP-132 Pages: 48, 26, 30, 30	U-665 + XP-335 Pages: 48, 26	U-665 + XU-662 + X P-335 Pages: 48, 30, 26
<b>4 mm, 3/16"</b>	P-135 + P-259 + NTSys + LT-115 + LBFF + XP-132 Pages: 48, 23, 19, 23, 30	P-135 + P-248 + LT-115 + LBFF + XP-132 Pages: 48, 23, 23, 30, 30	P-135 + XP-235 + F-252 + LBFF + XP-132 Pages: 48, 25, 19, 27, 30	P-135 + XP-235 + LBFF + XP-132 Pages: 48, 25, 30, 30	P-135 + XP-335 + LBFF + XP-132 Pages: 48, 27, 26, 30	P-135 + XP-335 + LBFF + XP-132 Pages: 48, 26, 30, 30	P-134 + (2) LBFF + (2) XP-132 Pages: 41, 27, 30, 30	U-659 + LBFF + XP-132 Pages: 48, 30, 30	U-659 + XU-662 + LBFF + XP-132 Pages: 48, 30, 27, 30, 30
<b>1/4"</b>	U-665 + P-259 + NTSlv + LT-115 Pages: 48, 23, 19, 23	U-665 + P-248 + LT-115 Pages: 48, 23, 23	U-665 + XP-235 + F-252 Pages: 48, 25, 19	U-665 + XP-235 Pages: 48, 25	U-665 + MFF + XP-335 Pages: 48, 27, 26	U-665 + XP-335 Pages: 48, 26	U-659 + LBFF + XP-132 Pages: 48, 30, 30	Contact Us	U-665 + P-684 + XU-662 Pages: 48, 48, 30
<b>5/16"</b>	U-665 + XU-662 + P-259 + NTSlv + LT-115 Pages: 48, 30, 60, 19, 23	U-665 + XU-662 + P-248 + LT-115 Pages: 48, 30, 23, 23	U-665 + XU-662 + XP-235 + F-252 Pages: 48, 30, 25, 19	U-665 + XU-662 + XP-235 Pages: 48, 30, 25	U-665 + XU-662 + MFF + XP-335 Pages: 48, 30, 27, 26	U-665 + XU-662 + XP-335 Pages: 48, 30, 26	U-659 + XU-662 + LBFF + XP-132 Pages: 48, 30, 27, 30, 30	U-665 + P-684 + XU-662 Pages: 48, 48, 30	Contact Us

**MTSlv** MicroTight® Sleeves. Select the appropriate MicroTight Sleeve(s) for your tubing OD size.  
**NTSls** NanoTight™ System. Select the appropriate NanoTight Sleeve(s) for your tubing OD size, and NanoTight fitting(s).  
**NTSlv** Select the appropriate NanoTight Sleeves for your tubing OD size.

**MFF** Select the appropriate Metric Flangeless Ferrule(s) for your tubing OD size. Choose from P-342, P-343, P-353, and P-363R.  
**LBFF** Select from the following Large-Bore Flangeless Ferrules: P-133 (3/16" OD) or P-139 (4.0 mm OD).

## VHP Stainless Steel ZDV Unions

- ▶ Supplied with fittings for 1/16" OD or 1/8" OD tubing
- ▶ Manufactured from 316 stainless steel
- ▶ All union assemblies rated to 20,000 psi (1,380 bar) or higher

These Upchurch Scientific® high pressure, zero-dead-volume (ZDV) unions, manufactured by IDEX Health & Science, are precision machined from 316 stainless steel, carefully passivated, then thoroughly rinsed. Each comes complete with stainless steel nuts and ferrules.

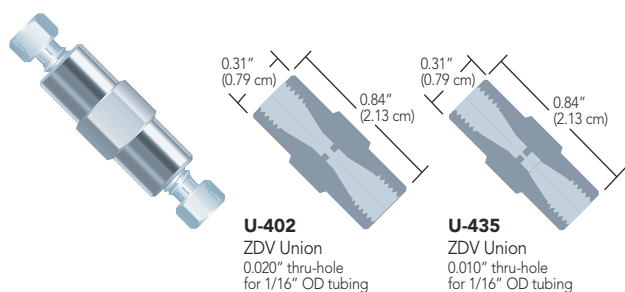
**U-402**

ZDV Union  
0.020" thru-hole  
for 1/16" OD tubing

**U-435**

ZDV Union  
0.010" thru-hole  
for 1/16" OD tubing

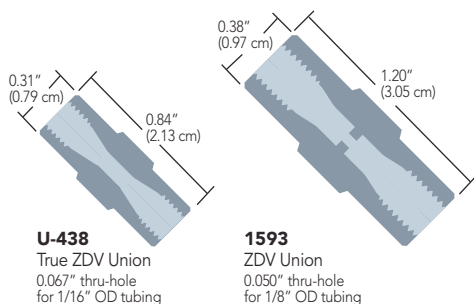
**U-438**

True ZDV Union  
0.067" thru-hole  
for 1/16" OD tubing

**1593**

ZDV Union  
0.050" thru-hole  
for 1/8" OD tubing

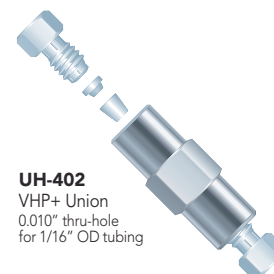
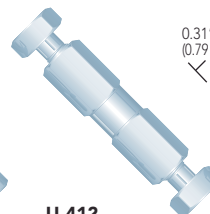
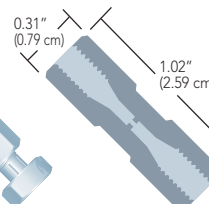
**U-411**  
NanoTight™ Union  
0.007" thru-hole  
for 1/16" OD tubing**UH-402**  
VHP+ Union  
0.010" thru-hole  
for 1/16" OD tubing**U-322**  
VICI® (Valco) Compatible  
ZDV Union  
0.020" thru-hole  
for 1/16" OD tubing**U-412**  
Waters Compatible  
ZDV Union  
0.020" thru-hole  
for 1/16" OD tubing

### NOTE

It is possible to order the products on this page without the fittings. Simply use a -01 at the end of the product number to order the union body without fittings.

Part No.	Description	Threads	Includes	Thru-hole	Swept Volume	Pressure Rating
<b>VHP STAINLESS STEEL ZDV UNIONS</b>						
<b>1593</b>	Stainless Steel Union for 1/8" OD Tubing	1/4-28 Coned	(2) C-235/C-236	0.050" (1.25 mm)	1.48 µL	20,000 psi (1,380 bar)
★ <b>U-402</b>	Stainless Steel Union for 1/16" OD Tubing	10-32 Coned	(2) U-400/U-401	0.020" (0.50 mm)	0.13 µL	20,000 psi (1,380 bar)
★ <b>U-411</b>	Stainless Steel Union for 1/16" OD Tubing	10-32 Coned	(2) U-400/U-401	0.007" (178 µm)	13 nL	20,000 psi (1,380 bar)
★ <b>U-435</b>	Stainless Steel Union for 1/16" OD Tubing	10-32 Coned	(2) U-400/U-401	0.010" (0.25 mm)	20 nL	20,000 psi (1,380 bar)
<b>U-438</b>	Stainless Steel Union for 1/16" OD Tubing	10-32 Coned	(2) U-400/U-401, (1) P-554 Gauge Plug	0.067" (1.70 mm)	Near 0 µL	20,000 psi (1,380 bar)
<b>UH-402</b>	VHP+ Stainless Steel Union for 1/16" OD Tubing	10-32 Coned	(2) VHP-200	0.010" (0.25 mm)	20 nL	30,000 psi (2,070 bar)
<b>VICI (VALCO) COMPATIBLE ZDV UNION</b>						
★ <b>U-322</b>	Stainless Steel Union for 1/16" OD Tubing	10-32 Coned	(2) U-320/U-321	0.020" (0.50 mm)	0.15 µL	20,000 psi (1,380 bar)
<b>WATERS® COMPATIBLE ZDV UNION</b>						
<b>U-412</b>	Stainless Steel Union for 1/16" OD Tubing	10-32 Coned	(2) U-410/U-401	0.020" (0.50 mm)	0.10 µL	20,000 psi (1,380 bar)



## VHP Unions for Capillary Tubing

- ▶ Featuring stainless steel bodies and PK/PEEK fittings
- ▶ Pressure rated up to 15,000 psi (1,034 bar)
- ▶ Options to direct-connect both 1/32" OD tubing and 360 µm OD tubing

Upchurch Scientific® has expanded its line of specialized fittings and connectors for UHPLC applications to include several innovative unions and adapters.

Two of these products — the UH-432 and UH-436 — follow the design of our popular Mini MicroFilters (see page 162) and allow a convenient union between either 1/32" OD tubing or 360 µm OD tubing. Each features a stainless steel union body and a unique stainless steel union capsule, enabling both excellent chemical compatibility as well as conductivity, making these a great choice for electrical interfacing in certain LC-MS applications. Each is also coupled with direct-connect ferrules made from our proprietary PEEK polymer blend (PK), allowing tubing connections up to 15,000 psi (1,034 bar). *(Please Note: While these connectors can be used at elevated pressures, they are not recommended for applications above 100 °C.)*

The UH-632 is a more traditionally designed connector, incorporating internally threaded ports. The union (UH-632) features a true ZDV (zero dead volume) connection between both tubes. This unique product is coupled with our one-piece Ultra-High Performance Fingertight fittings manufactured from our proprietary PEEK polymer blend, allowing them to be used in high temperature applications (up to 200 °C) at pressures up to 6,000 psi (414 bar) — or use these connectors at room temperature up to 15,000 psi (1,034 bar)!

The 1959-01 is a new VHP union designed to accept the popular M4x0.7 threaded fittings for 1/32" OD tubing, made popular by Rheodyne®. These unions will work nicely with both the VHP-900 fittings (found on page 7) as well as the reusable VHP-920 (found on page 8).

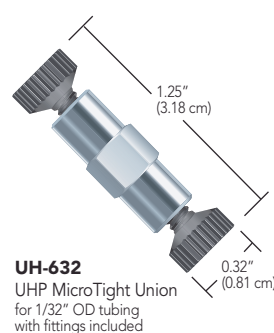
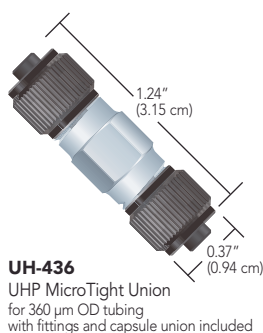
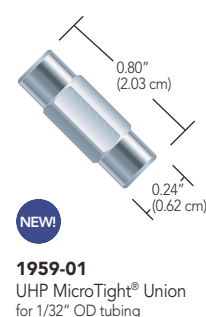
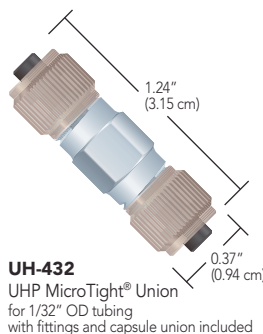

## APPLICATION NOTE

### What is a True ZDV Union?

True zero dead volume (ZDV) unions are designed so that the two joined pieces of tubing butt perfectly together as shown in the image to the right. These products have no swept volume contained within the union body. The fluid moves directly from one tube into another in this type of connector.

When using true ZDV unions, it is important to take care to ensure connecting tubing has burr-free 90 degree ends. Find tubing cutters on page 74 to assist with cleanly cutting polymer and fused silica tubing. Gauge plugs are supplied with True ZDV Unions to assist with assembly. With the gauge plug inserted into one side of the union, a hard stop is created for the tubing to bottom out against as it is connected to the opposite port. The gauge plug is removed and then the second piece of tubing is connected, using the first piece of tubing to bottom out against resulting in the two tubes joined together in the center of the union.

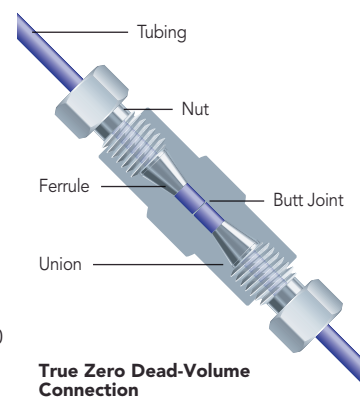

## ORDER ONLINE

## RELATED PRODUCTS

- ▶ Find replacement VHP fittings on page 9.
- ▶ Find Fused Silica tubing on page 67.
- ▶ Find 1/32" OD Stainless Steel tubing on page 64–65.
- ▶ To achieve 15,000 psi (1,034 bar) with the female threaded fittings used with some of these products, use the P-278 extender tool found on page 8.

Part No.	Description	Threads	Includes	Thru-hole	Swept Volume	Pressure Rating
<b>VHP UNIONS FOR CAPILLARY TUBING</b>						
★ UH-432	VHP Union for 1/32" OD Tubing, PEEK/SST	5/16-24 Coned	(2) PK-112, (2) P-416	0.006" (0.150 mm)	5 nL	15,000 psi (1,034 bar)
UH-436	VHP Union for 360 µm OD Tubing, PEEK/SST	5/16-24 Coned	(2) PK-152, (2) P-416BLK	0.006" (0.150 mm)	5 nL	15,000 psi (1,034 bar)
UH-632	VHP True ZDV Union for 1/32" OD Tubing, PEEK/SST	6-32 Coned	(2) PK-126, (1) P-553 Gauge Plug	N/A	N/A	15,000 psi (1,034 bar)
<b>NEW!</b> 1959-01	VHP Union for 1/32" OD Tubing, SST	M4x0.7	N/A (Fittings must be ordered separately)	0.007" (178 µm)	16 nL	30,000 psi (2,070 bar)

## New Bio-Inert UHPLC Unions

- ▶ Unique, Patent-Pending Process allows a fully-PEEK fluid contact area combined with the strength of stainless steel
- ▶ Pressure rated to 1,200 bar (17,400 psi)
- ▶ Two inner diameters available: 0.008" and 0.016"

Upchurch Scientific® introduces two new unions specifically engineered for Bio-Inert UHPLC applications. Combining the physical strength of 316 stainless steel with the inertness and biocompatibility of an all-PEEK fluid pathway, these unions will work well in applications where pressures reach up to 17,400 psi (1,200 bar) — without allowing metal contact by the fluid.

Neither union comes with fittings, but can be paired successfully with any 10-32 coned fitting that uses a polymer nose or ferrule.

*Note: All-stainless steel fittings should NOT be used with these unions, as they will damage the internal conical seat.*

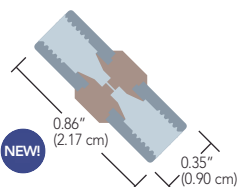
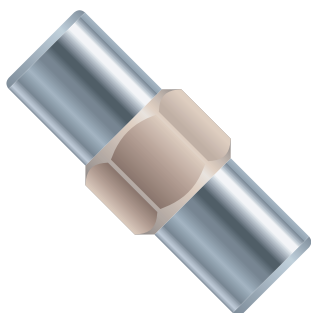

**UP-700**  
Bio-Inert UHPLC Union  
0.008" thru-hole  
for 1/16" OD tubing

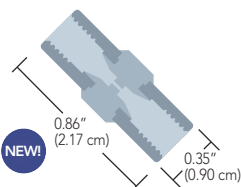

**UP-701**  
Bio-Inert UHPLC Union  
0.016" thru-hole  
for 1/16" OD tubing



## PEEK ZDV Unions

Upchurch Scientific PEEK zero-dead-volume (ZDV) Unions come complete with two F-300 Fingertight Fittings for 1/16" OD tubing and are pressure rated to 5,000 psi (344 bar).

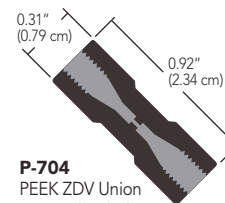
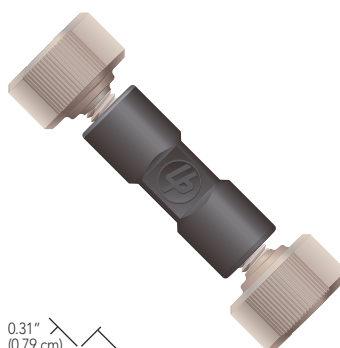

**P-704**  
PEEK ZDV Union  
0.020" thru-hole  
with F-300 Fittings

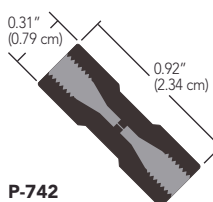

**P-742**  
PEEK ZDV Union  
0.010" thru-hole  
with F-300 Fittings

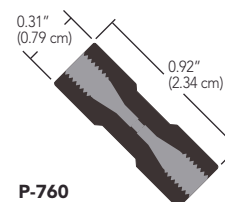

**P-760**  
PEEK ZDV Union  
0.050" thru-hole  
with F-300 Fittings

## NanoTight™ Union

This Upchurch Scientific NanoTight Union improves capillary tubing connections in several ways. The internal design of the union greatly reduces the incidence of tubing misalignment. When using 1/16" OD tubing sleeves (found on page 19) to connect capillary tubing, the webbed thru-hole minimizes breaking of fused silica while adding only miniscule swept volume. The results are fewer blockages, fewer flow rate reductions and fewer back pressure problems.

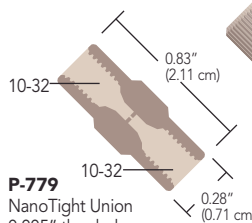
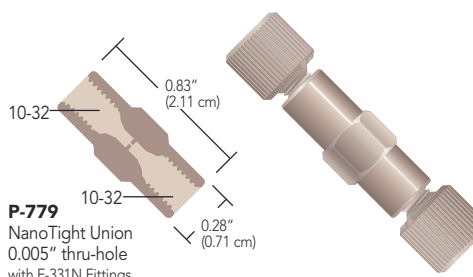

**P-779**  
NanoTight Union  
0.005" thru-hole  
with F-331N Fittings

Part No.	Description	Threads	Includes	Thru-hole	Swept Volume	Pressure Rating
<b>BIO-INERT UHPLC UNIONS</b>						
<b>NEW!</b> UP-700	Bio-Inert UHPLC Union for 1/16" OD Tubing, Natural (Tan)	10-32 Coned	N/A	0.008" (0.20 mm)	0.05 µL	17,400 psi (1,200 bar)
<b>NEW!</b> UP-701	Bio-Inert UHPLC Union for 1/16" OD Tubing, Gray	10-32 Coned	N/A	0.016" (0.40 mm)	0.20 µL	17,400 psi (1,200 bar)
<b>PEEK ZDV UNIONS</b>						
★ P-704	PEEK Union for 1/16" OD Tubing	10-32 Coned	(2) F-300	0.020" (0.50 mm)	0.28 µL	5,000 psi (344 bar)
★ P-742	PEEK Union for 1/16" OD Tubing	10-32 Coned	(2) F-300	0.010" (0.25 mm)	0.07 µL	5,000 psi (344 bar)
★ P-760	PEEK Union for 1/16" OD Tubing	10-32 Coned	(2) F-300	0.050" (1.25 mm)	1.2 µL	5,000 psi (344 bar)
<b>NANOTIGHT UNION</b>						
★ P-779	PEEK NanoTight Union for 1/16" OD Tubing and Tubing Sleeves	10-32 Coned	(2) F-331N	0.005" (125 µm)	8 nL	5,000 psi (344 bar)

## MicroTight® Connectors for Capillary Tubing

Connect two pieces of capillary tubing with these Upchurch Scientific® PEEK MicroTight Connectors. The True ZDV Unions allow two pieces of tubing to connect directly to each other — using the included gauge plug to ensure proper alignment. The standard union and elbow both feature a 0.006" (0.150 mm) thru-hole, adding only a small amount of additional flow-path volume to help ensure proper chromatographic results. For MicroTight unions designed for UHPLC applications, see page 37.

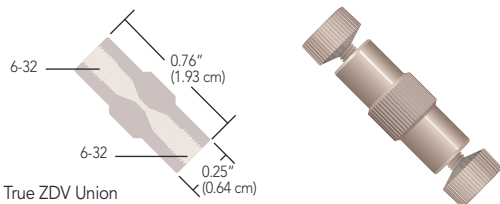

**P-720**  
MicroTight True ZDV Union  
for use with MicroTight Sleeves  
with fittings and gauge plug included

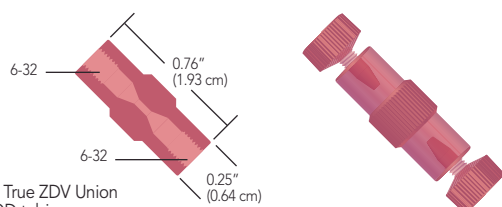

**P-771**  
MicroTight True ZDV Union  
for 1/32" OD tubing  
with fittings and gauge plug included

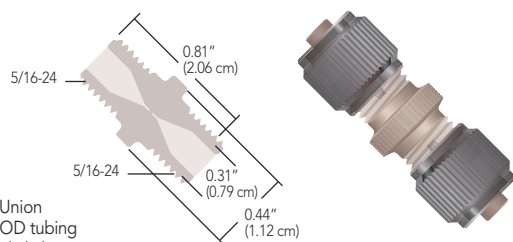

**P-772**  
MicroTight Union  
for 360 µm OD tubing  
with fittings included

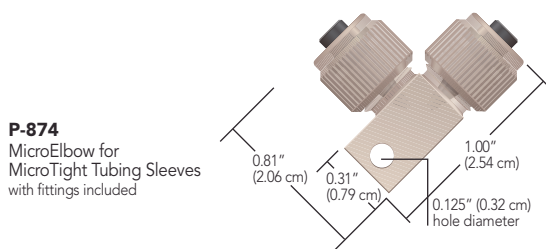

**P-874**  
MicroElbow for  
MicroTight Tubing Sleeves  
with fittings included

## Conductive MicroTight Union

The Upchurch Scientific Conductive MicroTight Union manufactured by IDEX Health & Science provide an excellent opportunity to introduce voltage into an electrospray or capillary electrophoresis system. With an extremely low internal volume of 16 nL, this union can be placed inline with 360 µm OD capillary tubing. Mount and apply voltage to these unions using our Insulating Mounting Bracket below.

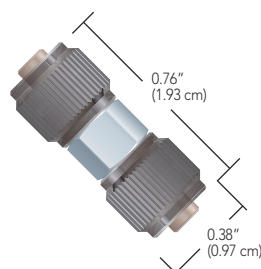

**M-572**  
Conductive MicroTight Union  
for 360 µm OD tubing  
with fittings and Capsule Union included

## Insulating Mounting Bracket

Use our Insulating Mounting Bracket to easily integrate the Conductive MicroTight Union (shown above) or our Conductive Mini MicroFilters (on page 162) into your system or lab.

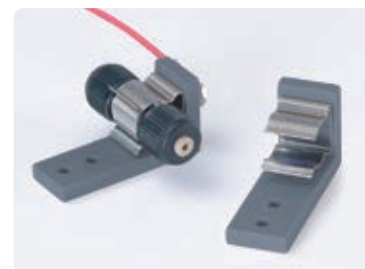

Insulating Mounting Bracket, shown with lead wire and Conductive MicroTight Union, not included.

The product snaps into place. Voltage from your lead wire is conducted through the attaching stainless steel nut and screw (included), then onto the mounted product via the stainless steel clip.

The bracket's base includes two holes (#2 screw clearance) for easy mounting onto any lab surface. Dimensions are 1.25" L x 0.45" W x 0.63" H.

## APPLICATION NOTE

For an example of using a Conductive MicroTight Union in a pressure driven ion preconcentration application see: "Self-Sealed Vertical Polymeric Nanoporous Junctions for High Throughput Nanofluidic Applications."

Sun Jae Kim and Jong Yoon Han. *Analytical Chem.* 2008, 80: 3507-3511.

Part No.	Description	Threads	Includes	Thru-hole	Swept Volume	Pressure Rating
<b>MICROTIGHT UNIONS</b>						
★ P-720	PEEK True ZDV Union for MicroTight Sleeves	6-32 Coned	(2) F-125, (1) P-553	N/A	N/A	4,000 psi (276 bar)
★ P-771	PEEK True ZDV Union for 1/32" OD Tubing	6-32 Coned	(2) F-126S, (1) P-553	N/A	N/A	5,000 psi (345 bar)
★ P-772	PEEK Union for 360 µm OD Tubing	5/16-24 Coned	(2) F-152, (2) P-416BLK	0.006" (0.150 mm)	5 nL	5,000 psi (345 bar)
P-874	PEEK MicroElbow for MicroTight Sleeves	5/16-24 Coned	(2) F-172, (2) P-416	0.006" (0.150 mm)	20 nL	4,000 psi (276 bar)
<b>REPLACEMENT GAUGE PLUGS (TO ACHIEVE TRUE ZDV CONNECTIONS WITH OUR P-720 AND P-771 UNIONS)</b>						
P-553	Gauge Plug, Delrin®	6-32 Coned	N/A	N/A	N/A	N/A
<b>CONDUCTIVE MICROTIGHT UNIONS</b>						
M-572	Conductive Union for 360 µm OD Tubing, PEEK/SST	5/16-24 Coned	(2) F-152, (2) P-416BLK, (1) M-128NF	0.011" (0.279 mm)	16 nL	5,000 psi (345 bar)
<b>INSULATING MOUNTING BRACKET</b>						
M-447	Insulating Mounting Bracket	N/A	N/A	N/A	N/A	N/A

## Low Pressure Unions

- ▶ Manufactured from PEEK, ETFE, Delrin®, polypropylene, or PCTFE
- ▶ Available with 1/4-28, M6, or 10-32 flat-bottom threads

Upchurch Scientific® Low Pressure Unions are available in a variety of polymers, providing several low-cost and chemically-resistant options. The union assemblies below include fittings as shown in the table. The unions in the right column do not include fittings, allowing for customizing the fitting selection. In some cases, a union can be configured to connect two different tubing sizes—for example, if 1/4-28 Flangeless fittings for 1/16" and 1/8" OD tubing were selected from pages 25 and 26 they can be used with the P-603 union to connect the two different tubing sizes.

### Low Pressure PEEK Union Assemblies

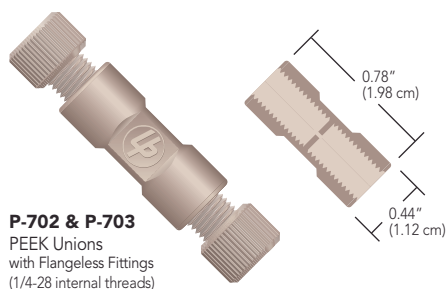

**P-702 & P-703**  
PEEK Unions  
with Flangeless Fittings  
(1/4-28 internal threads)

### Low Pressure ETFE Union Assemblies

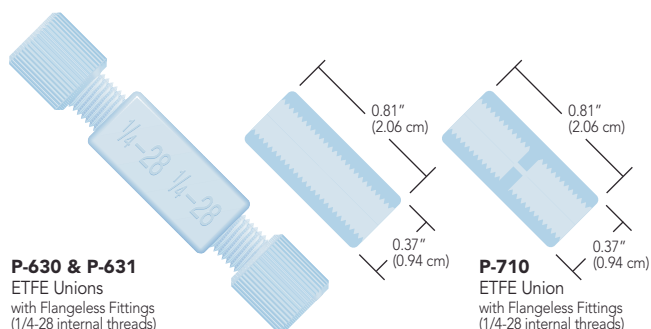

**P-630 & P-631**  
ETFE Unions  
with Flangeless Fittings  
(1/4-28 internal threads)

**P-710**  
ETFE Union  
with Flangeless Fittings  
(1/4-28 internal threads)

### Low Pressure Standard Unions

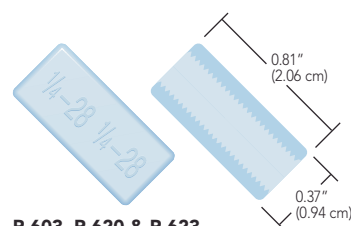

**P-603, P-620 & P-623**  
Standard Unions  
(1/4-28 internal threads)

### Low Pressure Metric Unions

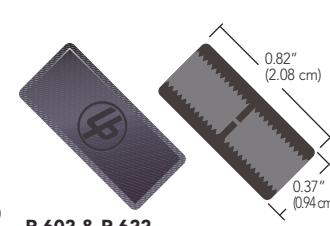

**P-602 & P-622**  
Metric Unions  
(M6 internal threads)

### Low Pressure Male Union

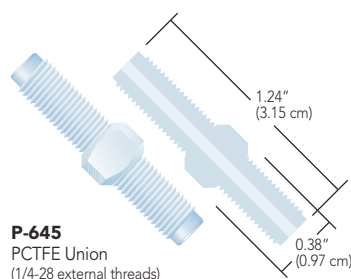

**P-645**  
PCTFE Union  
(1/4-28 external threads)

### VacuTight™ Union

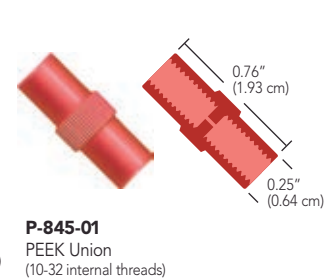

**P-845-01**  
PEEK Union  
(10-32 internal threads)



## RELATED PRODUCTS

- ▶ To use connectors in higher pressure applications, simply replace the provided fittings with Super Flangeless™ Nuts and Ferrules, found on pages 21–23.
- ▶ Use any of the 10-32 flat-bottom fittings on page 21 and 28 to make an inline connection with our VacuTight Union. This product is designed for use with 1/16" OD tubing.

Part No.	Description	Color	Threads	Includes	Thru-hole	Swept Volume	Pressure Rating
<b>PEEK UNION ASSEMBLIES</b>							
★ P-702	PEEK Union for 1/16" OD Tubing	Natural	1/4-28 FB	(2) XP-235	0.020" (0.50 mm)	0.41 µL	1,000 psi (69 bar)
★ P-703	PEEK Union for 1/8" OD Tubing	Natural	1/4-28 FB	(2) XP-335	0.050" (1.25 mm)	2.57 µL	1,000 psi (69 bar)
<b>ETFE UNION ASSEMBLIES</b>							
P-630	ETFE True ZDV Union for 1/16" OD Tubing	Natural	1/4-28 FB	(2) P-200N/P-245	N/A	N/A	1,000 psi (69 bar)
P-631	ETFE True ZDV Union for 1/8" OD Tubing	Natural	1/4-28 FB	(2) P-300N/P-345	N/A	N/A	1,000 psi (69 bar)
P-710	ETFE Union for 1/16" OD Tubing	Natural	1/4-28 FB	(2) XP-245	0.030" (0.75 mm)	0.93 µL	1,000 psi (69 bar)
<b>STANDARD UNIONS</b>							
★ P-603	Delrin True ZDV Standard Union	Natural	1/4-28 FB	N/A	N/A	N/A	N/A*
★ P-620	Polypropylene True ZDV Standard Union	Natural	1/4-28 FB	N/A	N/A	N/A	N/A*
★ P-623	ETFE True ZDV Standard Union	Natural	1/4-28 FB	N/A	N/A	N/A	N/A*
<b>METRIC UNIONS</b>							
P-602	Delrin Metric Union	Black	M6 FB	N/A	0.020" (0.50 mm)	0.41 µL	N/A*
P-622	ETFE Metric Union	Blue	M6 FB	N/A	0.020" (0.50 mm)	0.41 µL	N/A*
<b>MALE UNION</b>							
★ P-645	PCTFE Male Union	Natural	1/4-28 FB	N/A	0.062" (1.60 mm)	61.3 µL	500 psi (34 bar)
<b>VACUTIGHT UNION</b>							
P-845-01	PEEK Union for 1/16" OD Tubing	Red	10-32 FB	N/A	0.020" (0.50 mm)	0.20 µL	N/A*

\* Pressure Rating depends on Fittings selected. See pressure rating for fittings on appropriate page.  
FB = Flat-Bottom

## Bulkhead Unions

- ▶ Designed for plumbing tubing through equipment housing
- ▶ For use with standard 10-32 coned or 1/4-28 flat-bottom threaded fittings

Thread Upchurch Scientific® PEEK Bulkhead Unions directly through your equipment housing to connect internal tubing to the outside. Each union has unique 3/8-24 external threads and comes complete with a stainless steel nut and lock washer to hold it in place. Requires a 3/8" hole to mount. The recommended torque limit for these unions is 15 in.-lbs (1.7 N-m).

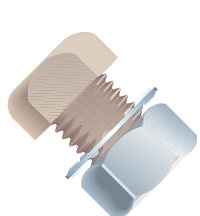

**Bulkhead Union**  
includes stainless steel nut/lock washer

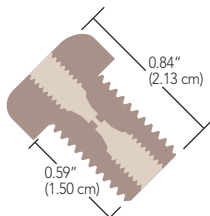

**P-440**  
10-32 internal threads

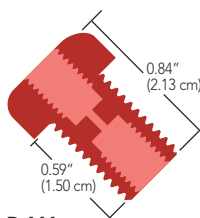

**P-441**  
1/4-28 internal threads

## Elbow Connectors

Use these Elbow Connectors to easily navigate tight corners. One Elbow is designed for use with 1/16" OD tubing and has a 0.020" (0.50 mm) thru-hole. Use 1/8" OD tubing with the other Elbow, which has a 0.062" (1.6 mm) thru-hole. Both come complete with 1/4-28 PEEK nuts and ETFE ferrules, and are pressure rated to 1,000 psi (69 bar).

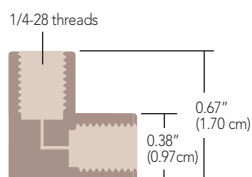

**P-430**  
PEEK Elbow  
comes with Flangeless Fittings



## Large Bore Union

- ▶ 5/16-24 flat-bottom threads

Use any of the 5/16-24 fittings on page 55 and the appropriate ferrule to create a true zero dead volume (ZDV) connection with the P-134 Union.

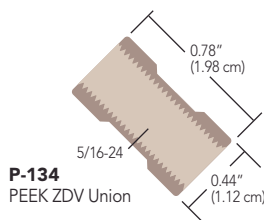

**P-134**  
PEEK ZDV Union

## RELATED PRODUCTS

- ▶ Stainless Steel Bulkhead Unions are also available. Please contact us for more information.
- ▶ To use Elbows in higher pressure applications, simply replace the provided fittings with Super Flangeless™ Nuts and Ferrules, found on pages 21–23.

Part No.	Description	Threads	Color	Includes	Thru-hole	Swept Volume
<b>BULKHEAD UNIONS</b>						
★ P-440	PEEK Bulkhead Union	10-32 Coned	Natural	(1) SST Nut/Washer	0.020" (0.50 mm)	1.9 µL
★ P-441	PEEK Bulkhead Union	1/4-28 Flat-Bottom	Red	(1) SST Nut/Washer	0.040" (1.00 mm)	2.9 µL
★ P-441N	PEEK Bulkhead Union	1/4-28 Flat-Bottom	Natural	(1) SST Nut/Washer	0.040" (1.00 mm)	2.9 µL
<b>ELBOW CONNECTORS</b>						
P-430	PEEK Elbow for 1/16" OD Tubing	1/4-28 Flat-Bottom	Natural	(2) XP-235	0.020" (0.50 mm)	1.4 µL
P-432	PEEK Elbow for 1/8" OD Tubing	1/4-28 Flat-Bottom	Natural	(2) XP-335	0.062" (1.60 mm)	13.6 µL
<b>LARGE BORE UNION</b>						
P-134	PEEK True ZDV Union	5/16-24 Flat-Bottom	Natural	N/A	N/A	N/A

## VHP Tee for 1/16" OD Tubing

IDEX Health & Science offers this Very High Pressure (VHP) Tee Connector, designed to bring three pieces of tubing together. The all-316 stainless steel connector is designed for 1/16" OD tubing and is pressure rated to 30,000 psi (2,070 bar).

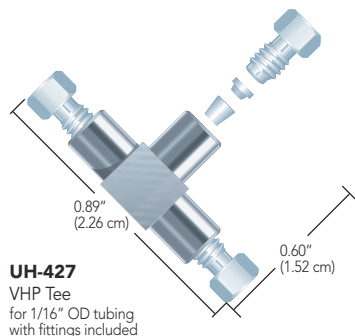

## VHP Tees & Crosses for Capillary Tubing

- ▶ Direct-connect either 360  $\mu$ m or 1/32" OD tubing — no sleeves required!
- ▶ Available in both tee and cross configurations
- ▶ Pressure rated to 15,000 psi (1,034 bar)

To help facilitate multi-port connections in UHPLC applications, Upchurch Scientific® has developed a line of MicroTees and MicroCrosses, manufactured from stainless steel and featuring small thru-holes and very low internal volume. Additionally, the stainless steel construction allows these products to be used in applications where electrical conductivity is desired.

Included with the MicroTees and MicroCrosses are the VHP MicroFerrules found on page 9. The P-278 Extender Tool on page 33 can be used to tighten the female nuts that are included with these connectors.

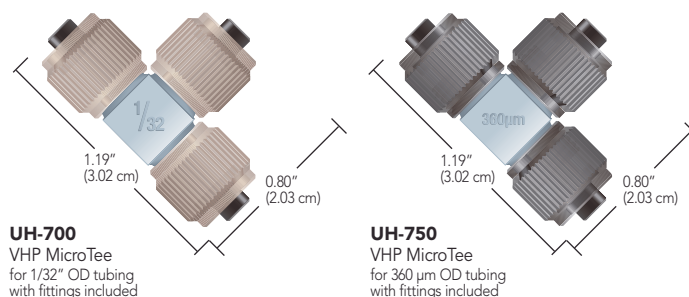

**UH-700**  
VHP MicroTee  
for 1/32" OD tubing  
with fittings included

**UH-750**  
VHP MicroTee  
for 360  $\mu$ m OD tubing  
with fittings included

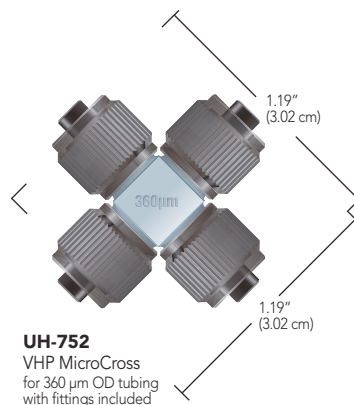

**UH-752**  
VHP MicroCross  
for 360  $\mu$ m OD tubing  
with fittings included

## APPLICATION NOTE

### Why 1/32" OD Tubing and 360 $\mu$ m OD Tubing?

IDEX Health & Science has focused strongly on the development of a variety of connectors and accessories for 1/32" OD tubing and 360  $\mu$ m OD tubing. We have focused on these specific sizes due to their overwhelming popularity in analytical instruments, especially where micro and nano-scale analyses are being performed. By creating products designed for these popular sizes, the overall connection is easier to make and generally holds to increased pressures over connections where tubing sleeves are involved.

Part No.	Description	Threads	Includes	Thru-hole	Swept Volume	Pressure Rating
<b>VHP TEE FOR 1/16" OD TUBING</b>						
<b>UH-427</b>	VHP Tee for 1/16" OD Tubing, SST	10-32 Coned	(3) VHP-200	0.020" (0.50 mm)	0.57 $\mu$ L	30,000 psi (2,070 bar)
<b>VHP TEES &amp; CROSSES FOR CAPILLARY TUBING</b>						
★ <b>UH-700</b>	VHP MicroTee for 1/32" OD Tubing, PEEK/SST	5/16-24 Coned	(3) PK-112, (3) P-416	0.010" (0.25 mm)	84 nL	15,000 psi (1,034 bar)
<b>UH-750</b>	VHP MicroTee for 360 $\mu$ m OD Tubing, PEEK/SST	5/16-24 Coned	(3) PK-152, (3) P-416BLK	0.010" (0.25 mm)	84 nL	15,000 psi (1,034 bar)
<b>UH-752</b>	VHP MicroCross for 360 $\mu$ m OD Tubing, PEEK/SST	5/16-24 Coned	(4) PK-152, (4) P-416BLK	0.010" (0.25 mm)	101 nL	15,000 psi (1,034 bar)



## Stainless Steel Tees & Crosses

These 316 stainless steel connectors come complete with 10-32 stainless steel fittings for use with 1/16" OD tubing and are rated to 20,000 psi (1,380 bar). They are compatible with any 10-32 coned threaded fittings.

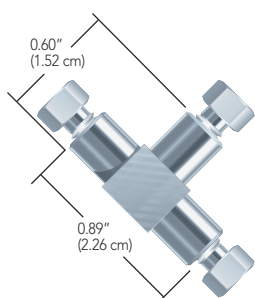

**U-428 Stainless Steel Tee**  
0.020" thru-hole  
with U-400 and U-401 Fittings

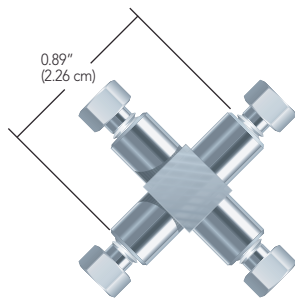

**U-430 Stainless Steel Cross**  
0.020" thru-hole  
with U-400 and U-401 Fittings

## PEEK 7-Port Manifold

Combine several streams into one or split one fluid stream into several. This PEEK 7-Port Manifold comes complete with F-331 Fingertight Fittings for 1/16" OD tubing and offers a pressure rating of 5,000 psi (345 bar). Seal unused ports with any of our polymer 10-32 coned plugs on page 32.

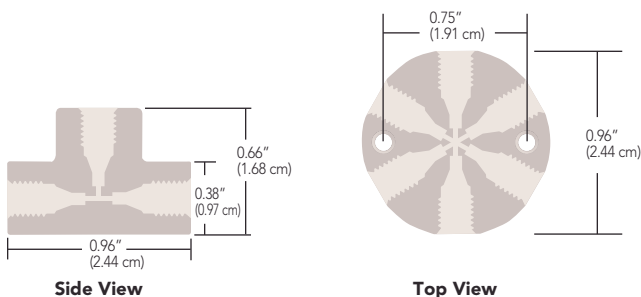

**P-170**  
PEEK 7-Port Manifold  
0.020" thru-holes  
with F-331 Fittings

## PEEK Tees & Crosses

Our PEEK Tees and Crosses include high pressure F-300 PEEK Fingertight Fittings — allowing maximum operating pressures to 3,500 psi (241 bar) when used with 1/16" OD PEEK or stainless steel tubing.

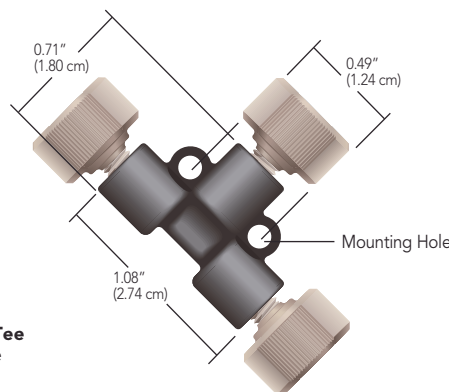

**P-727 PEEK Tee**  
0.020" thru-hole  
with F-300 Fittings

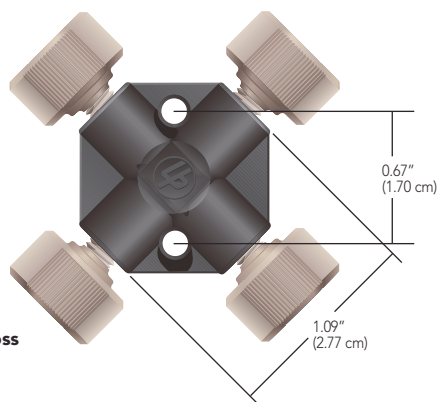

**P-729 PEEK Cross**  
0.020" thru-hole  
with F-300 Fittings



Part No.	Description	Threads	Includes	Thru-hole	Swept Volume	Pressure Rating
<b>VHP TEE FOR 1/16" OD TUBING</b>						
★ U-428	Stainless Steel Tee for 1/16" OD Tubing	10-32 Coned	(3) U-400, (3) U-401	0.020" (0.50 mm)	0.57 µL	20,000 psi (1,380 bar)
★ U-429	Stainless Steel Tee for 1/16" OD Tubing	10-32 Coned	(3) U-400, (3) U-401	0.040" (1.00 mm)	2.1 µL	20,000 psi (1,380 bar)
★ U-430	Stainless Steel Cross for 1/16" OD Tubing	10-32 Coned	(4) U-400, (4) U-401	0.020" (0.50 mm)	0.72 µL	20,000 psi (1,380 bar)
★ U-431	Stainless Steel Cross for 1/16" OD tubing	10-32 Coned	(4) U-400, (4) U-401	0.040" (1.00 mm)	2.5 µL	20,000 psi (1,380 bar)
<b>PEEK MANIFOLD</b>						
P-170	PEEK 7-Port Manifold for 1/16" OD Tubing	10-32 Coned	(7) F-331	0.020" (0.50 mm)	2.2 µL	5,000 psi (345 bar)
<b>PEEK TEES AND CROSSES</b>						
★ P-727	PEEK Tee for 1/16" OD Tubing	10-32 Coned	(3) F-300	0.020" (0.50 mm)	0.57 µL	3,500 psi (241 bar)
P-728	PEEK Tee for 1/16" OD Tubing	10-32 Coned	(3) F-300	0.050" (1.25 mm)	3.0 µL	3,500 psi (241 bar)
P-729	PEEK Cross for 1/16" OD Tubing	10-32 Coned	(4) F-300	0.020" (0.50 mm)	0.72 µL	3,500 psi (241 bar)



## Static Mixing Tees

- ▶ PEEK body with two-piece fingertight fittings
- ▶ Low swept volume

Upchurch Scientific® Static Mixing Tees are ideal for microbore or analytical gradient HPLC. They have a low swept volume of 2.2  $\mu\text{L}$  (includes frit volume) and are designed for flow rates of 0.5 to 3 mL/min and a maximum pressure of 5,000 psi (345 bar). The back pressure caused by the tee is typically only 10 to 20 psi (0.7 to 1.4 bar) at these flow rates. The thru-holes are 0.020" (0.50 mm) and the center port features a 10  $\mu\text{m}$  UHMWPE or stainless steel frit that aids mixing.

### NOTE

- ▶ Turbulent mixing of solvents often increases outgassing. To maintain a bubble-free fluid pathway, we recommend solvent degassing when using this product.
- ▶ The frit incorporated into our U-466 and U-466S Static Mixing Tees is not replaceable. If it becomes clogged, the Mixing Tee must be replaced.

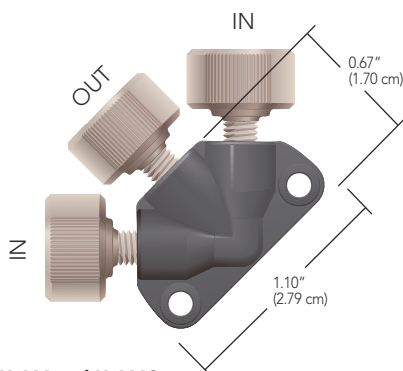

**U-466 and U-466S**  
Static Mixing Tees  
with F-300 Fingertight Fittings  
for 1/16" OD tubing

## Micro Static Mixing Tee

- ▶ Constructed of inert PEEK and PCTFE
- ▶ Low swept volume of 0.95  $\mu\text{L}$
- ▶ Designed for flow rates of 20–250  $\mu\text{L}/\text{min}$

The Upchurch Scientific® Micro Static Mixing Tee utilizes a specifically engineered internal geometry to efficiently mix two fluid streams into one combined stream. The center port also features a 0.5  $\mu\text{m}$  porosity PEEK polymer frit to aid in mixing. This frit adds a maximum of 20 psi (1.4 bar) back pressure to most systems (within the stated flow rate range). The Mixing Tee handles a maximum pressure of 5,000 psi (345 bar) when directly connecting 1/16" OD tubing, or up to 4,000 psi (276 bar) with capillary tubing when using our NanoTight™ Fittings and Tubing Sleeves (pages 17 and 19).

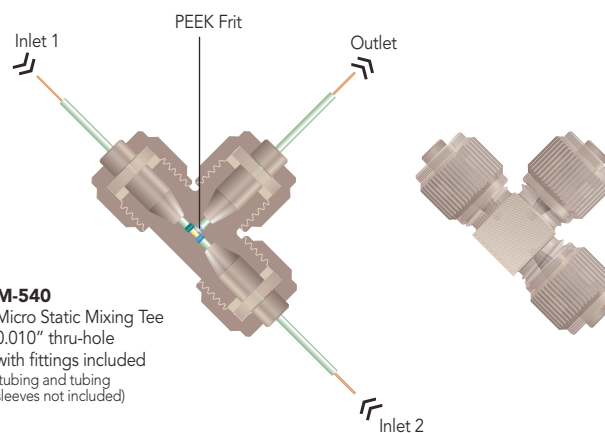

**M-540**  
Micro Static Mixing Tee  
0.010" thru-hole  
with fittings included  
(tubing and tubing  
sleeves not included)

### RELATED PRODUCTS

- ▶ See the Systec® Vacuum Degassing Systems on pages 178.
- ▶ Our standard Static Mixing Tees are designed for flow rates from 0.5 mL/min to 3 mL/min.

Part No.	Description	Threads	Includes	Thru-hole	Swept Volume	Pressure Rating
<b>STATIC MIXING TEE</b>						
U-466	PEEK Static Mixing Tee for 1/16" OD Tubing, 10 $\mu\text{m}$ UHMWPE Frit	10-32 Coned	(3) F-300	0.020" (0.50 mm)	2.2 $\mu\text{L}$	5,000 psi (345 bar)
★ U-466S	PEEK Static Mixing Tee for 1/16" OD Tubing, 10 $\mu\text{m}$ SST Frit	10-32 Coned	(3) F-300	0.020" (0.50 mm)	2.2 $\mu\text{L}$	5,000 psi (345 bar)
<b>MICRO STATIC MIXING TEE</b>						
★ M-540	PEEK Micro Static Mixing Tee, for 1/16" OD Tubing	5/16-24 Coned	(3) F-132/P-416	0.010" (0.250 mm)	0.95 $\mu\text{L}$	5,000 psi (345 bar)

## MicroTee & Cross for Capillary Tubing

- ▶ Direct connect 1/16", 1/32", 360 µm OD tubing, plus other capillary tubing
- ▶ Low swept volume

Use Upchurch Scientific® MicroTees and MicroCrosses to join capillary tubing. All of these products are made entirely of PEEK and have 0.006" (0.150 mm) thru-holes, with resulting swept volumes ranging from 29 to 81 nL.

### NOTE

- ▶ Use only the ferrules supplied with each connector — they are not interchangeable. Replacement ferrules and female nuts are available on page 18. For MicroUnions, MicroTees, and MicroCrosses for UHPLC applications, see page 42.

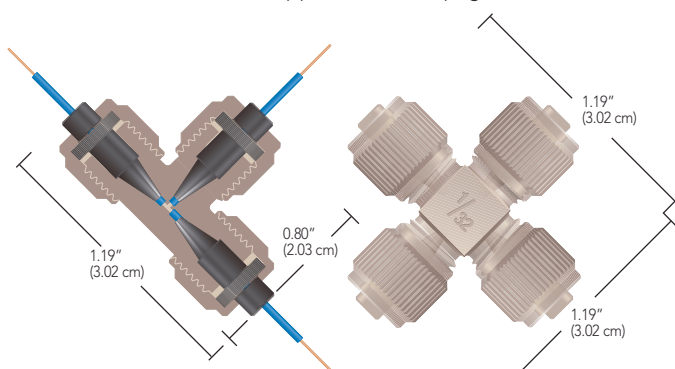

**P-775**  
MicroTee for MicroTight® Tubing Sleeves  
0.006" thru-holes  
with fittings included  
(tubing sleeves not included)

**P-887**  
MicroCross  
for 1/32" OD tubing  
0.006" thru-holes  
with fittings included

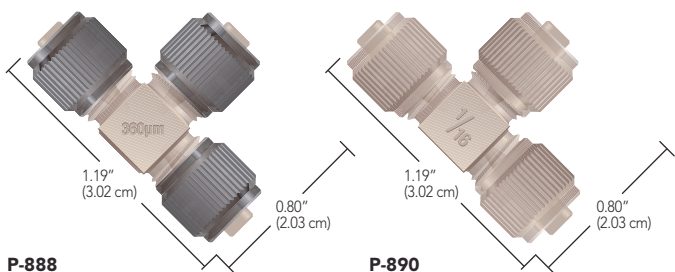

**P-888**  
MicroTee  
for 360 µm OD tubing  
0.006" thru-holes  
with fittings included

**P-890**  
MicroTee  
for 1/16" OD tubing  
0.006" thru-holes  
with fittings included



### APPLICATION NOTE

Several researchers use our PEEK MicroTee to introduce ionizing voltage to their fluid stream just prior to a Mass Spectrometer<sup>1</sup>. MicroTees are well suited for this application due to advantageous internal geometry and PEEK polymer's electrical resistance. The materials required for this setup are as follows: one gold or platinum conducting wire, one P-775 or P-875 MicroTee (this page), one MicroTight Tubing Sleeve (page 19) for the conducting wire (as needed to accommodate wire diameter), and at least two more MicroTight Tubing Sleeves (page 19) to connect your capillary tubing.

To set up a similar connection, first thread your wire through the appropriate tubing sleeve, if necessary, with the wire extending beyond both ends of the sleeve. Slip the female nut included with the MicroTee over the wire or sleeved wire, followed by the ferrule — ensuring the wire (and its sleeve) extends well past the end of the ferrule tip. Align the tip of the wire with the thru-hole of the MicroTee and gently insert the wire until it bottoms out. Now finger tighten the female nut into place. Attach your flow path tubing to the MicroTee's two other available ports, following the instructions provided with the MicroTee.

Begin fluid flow through the tee and apply voltage to the conducting wire lead. This setup typically provides effective electro spray ionization in applications having a flow rate of 100 µL/min or greater.

<sup>1</sup> One such paper describing pioneering electrospray work: **Protein Identification at the Low Femtomole Level from Silver-Stained Gels Using a New Fritless Electrospray Interface for Liquid Chromatography-Microspray and Nanospray Mass Spectrometry**. Christine L. Gatlin, Gerd R. Kleemann, Lara G. Hays, Andrew J. Link, John R. Yates III (1998) *Analytical Biochemistry* 263, 93-101.

Part No.	Description	Threads	Includes	Thru-hole	Swept Volume	Pressure Rating
<b>MICROTEE, MICROCROSS AND MICROELBOW</b>						
★ P-775	PEEK MicroTee for MicroTight Sleeves	5/16-24 Coned	(3) F-172, (3) P-416	0.006" (0.150 mm)	29 nL	4,000 psi (276 bar)
★ P-777	PEEK MicroCross for MicroTight Sleeves	5/16-24 Coned	(4) F-172, (4) P-416	0.006" (0.150 mm)	38 nL	4,000 psi (276 bar)
P-875	PEEK MicroTee with Mounting Hole, for MicroTight Sleeves	5/16-24 Coned	(3) F-172, (3) P-416	0.006" (0.150 mm)	29 nL	4,000 psi (276 bar)
★ P-885	PEEK MicroTee for 1/32" OD Tubing	5/16-24 Coned	(3) F-112, (3) P-416	0.006" (0.150 mm)	29 nL	5,000 psi (345 bar)
P-887	PEEK MicroCross for 1/32" OD Tubing	5/16-24 Coned	(4) F-112, (4) P-416	0.006" (0.150 mm)	38 nL	5,000 psi (345 bar)
★ P-888	PEEK MicroTee for 360 µm OD Tubing	5/16-24 Coned	(3) F-152, (3) P-416BLK	0.006" (0.150 mm)	29 nL	5,000 psi (345 bar)
P-889	PEEK MicroCross for 360 µm OD Tubing	5/16-24 Coned	(4) F-152, (4) P-416BLK	0.006" (0.150 mm)	38 nL	5,000 psi (345 bar)
★ P-890	PEEK MicroTee for 1/16" OD Tubing	5/16-24 Coned	(3) F-132, (3) P-416	0.006" (0.150 mm)	58 nL	5,000 psi (345 bar)
P-891	PEEK MicroCross for 1/16" OD Tubing	5/16-24 Coned	(4) F-132, (4) P-416	0.006" (0.150 mm)	81 nL	5,000 psi (345 bar)

## Low Pressure Tees & Crosses

Upchurch Scientific® Low Pressure Tees and Crosses manufactured by IDEX Health & Science are available in two inert polymers and can handle pressures to 500 psi (34 bar) or 1,000 psi (69 bar), depending upon the configuration of the products. Each is designed with handy mounting holes. All ETFE Tees and Crosses ship complete with 1/4-28 PFA Flangeless nuts and ETFE ferrules, while their PEEK polymer counterparts ship with 1/4-28 PEEK nuts and ETFE ferrules. Replacement fittings are located on pages 25 and 26.

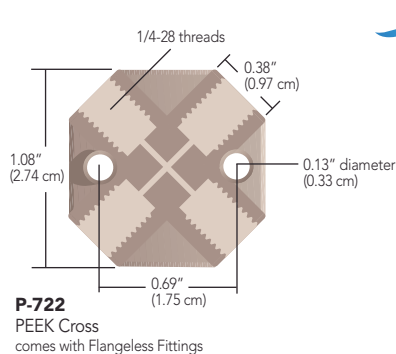
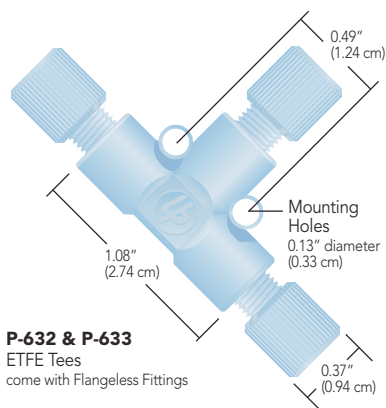

### NOTE

- ▶ To order just the body of one of our tees and crosses without fittings, simply add a '-01' to the part number — e.g., P-632-01.

### RELATED PRODUCTS

- ▶ Seal off unused ports with any of our 1/4-28 flat-bottom plugs found on page 32.
- ▶ To use the PEEK polymer versions of our Tees and Crosses in higher pressure applications, simply replace the provided fittings with Super Flangeless™ Nuts and Ferrules, found on pages 21-23.
- ▶ High Pressure Tees, Crosses, and a 7-Port Manifold (all with 10-32 threaded ports) are on page 43.

Part No.	Description	Threads	Includes	Thru-hole	Swept Volume	Pressure Rating
<b>LOW PRESSURE TEES AND CROSSES</b>						
★ P-632	ETFE Tee for 1/16" OD Tubing	1/4-28 Flat-Bottom	(3) P-245, (3) P-200N	0.020" (0.50 mm)	2.9 µL	1,000 psi (69 bar)
★ P-633	ETFE Tee for 1/8" OD Tubing	1/4-28 Flat-Bottom	(3) P-345, (3) P-300N	0.050" (1.25 mm)	17.5 µL	500 psi (34 bar)
P-634	ETFE Cross for 1/16" OD Tubing	1/4-28 Flat-Bottom	(4) P-245, (4) P-200N	0.020" (0.50 mm)	3.8 µL	1,000 psi (69 bar)
P-635	ETFE Cross for 1/8" OD Tubing	1/4-28 Flat-Bottom	(4) P-345, (4) P-300N	0.050" (1.25 mm)	22.8 µL	500 psi (34 bar)
★ P-712	PEEK Tee for 1/16" OD Tubing	1/4-28 Flat-Bottom	(3) XP-235	0.020" (0.50 mm)	2.9 µL	1,000 psi (69 bar)
★ P-713	PEEK Tee for 1/8" OD Tubing	1/4-28 Flat-Bottom	(3) XP-335	0.050" (1.25 mm)	17.5 µL	500 psi (34 bar)
★ P-714	PEEK Tee for 1/16" OD Tubing	1/4-28 Flat-Bottom	(3) XP-235	0.040" (1.00 mm)	11.4 µL	1,000 psi (69 bar)
P-722	PEEK Cross for 1/16" OD Tubing	1/4-28 Flat-Bottom	(4) XP-235	0.020" (0.50 mm)	3.8 µL	1,000 psi (69 bar)
P-723	PEEK Cross for 1/8" OD Tubing	1/4-28 Flat-Bottom	(4) XP-335	0.050" (1.25 mm)	22.8 µL	500 psi (34 bar)

## Manifolds

Choose a 5, 7, or 9 Port Manifold to combine several streams into one, or split one fluid stream into several. Each PEEK manifold comes complete with 1/4-28 Super Flangeless™ Fittings for either 1/16" or 1/8" OD tubing, with pressure ratings of 2,000 psi (138 bar) and 500 psi (34 bar), respectively.

A few useful applications include:

- ▶ Multiport mixing chamber
- ▶ Gas sparging splitting union
- ▶ Sample injection onto multi-well plates or a multiple direction flow path union

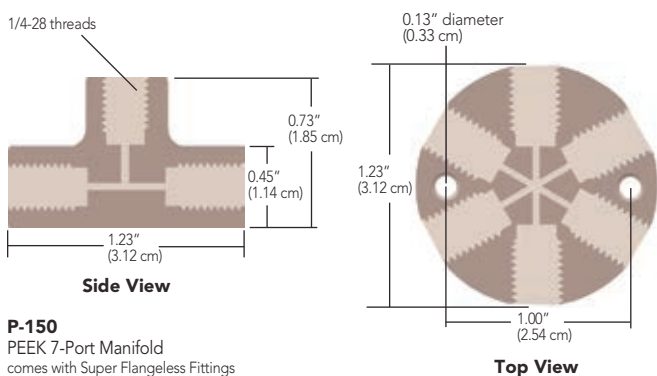

**P-150**  
PEEK 7-Port Manifold  
comes with Super Flangeless Fittings

## Y Connectors

Upchurch Scientific® PEEK Y Connectors are designed to split a stream or join two streams together, just like a tee. However, the configuration of a tee can lead to turbulent flow and solvent outgassing, which increases baseline noise and reduces sensitivity. The geometry of a Y connector creates less turbulence and thus can improve analytical results.

All of these Y Connectors use 1/4-28 Flangeless fittings, except P-515 which uses 5/16-24 fittings (to accommodate larger tubing).

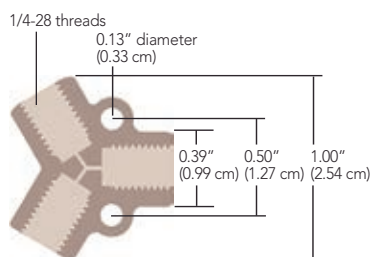

**P-512**  
PEEK Y  
comes with Flangeless Fittings



Part No.	Description	Threads	Includes	Thru-hole	Swept Volume	Pressure Rating
<b>MANIFOLDS</b>						
<b>Standard</b>						
★ P-150	PEEK 7-Port Manifold for 1/16" OD Tubing	1/4-28 FB	(7) P-255, (7) P-250	0.040" (1.00 mm)	42.0 µL	1,000 psi (69 bar)
P-154	PEEK 5-Port Manifold for 1/16" OD Tubing	1/4-28 FB	(5) P-255, (5) P-250	0.040" (1.00 mm)	22.3 µL	1,000 psi (69 bar)
P-155	PEEK 5-Port Manifold for 1/8" OD Tubing	1/4-28 FB	(5) P-331, (5) P-359	0.062" (1.60 mm)	53.8 µL	500 psi (34 bar)
★ P-190	PEEK 9-Port Manifold for 1/8" OD Tubing	1/4-28 FB	(9) P-331, (9) P-359	0.062" (1.60 mm)	160 µL	500 psi (34 bar)
P-191	PEEK 9-Port Manifold for 1/16" OD Tubing	1/4-28 FB	(9) P-255, (9) P-250	0.040" (1.00 mm)	139 µL	1,000 psi (69 bar)
<b>Y CONNECTORS</b>						
★ P-512	PEEK Y for 1/16" OD Tubing	1/4-28 FB	(3) XP-235	0.020" (0.50 mm)	1.7 µL	1,000 psi (69 bar)
P-513	PEEK Y for 1/8" OD Tubing	1/4-28 FB	(3) XP-335	0.040" (1.00 mm)	6.0 µL	500 psi (34 bar)
★ P-514	PEEK Y for 1/8" OD Tubing	1/4-28 FB	(3) XP-335	0.060" (1.50 mm)	13.6 µL	500 psi (34 bar)
P-515	PEEK Y for 3/16" OD Tubing	5/16-24 FB	(3) XP-132	0.125" (3.20 mm)	47.7 µL	500 psi (34 bar)

FB = Flat-Bottom

## Threaded Adapters

- ▶ Threaded adapters in a variety of configurations
- ▶ Both English and Metric threaded adapters offered
- ▶ Bring together connectors with different threads
- ▶ Manufactured from inert polymers — PEEK, PCTFE, ETFE, and PTFE

### English Threaded Adapters

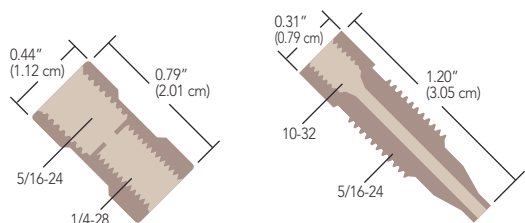

**P-135**  
0.080" (2.05 mm) thru-hole

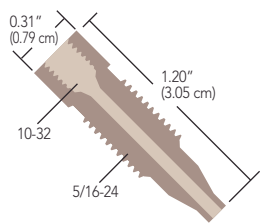

**6000-076**  
0.066" (1.70 mm) thru-hole

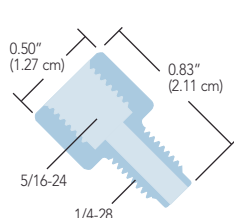

**P-681**  
0.125" (3.20 mm) thru-hole

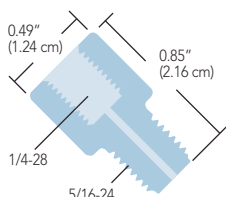

**P-718**  
0.040" (1.00 mm) thru-hole

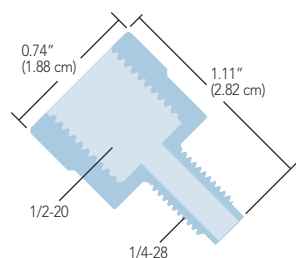

**P-684**  
0.130" (3.30 mm) thru-hole

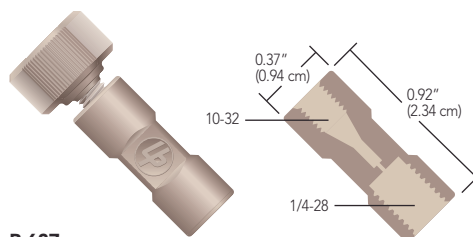

**P-627**  
0.020" (0.50 mm) thru-hole  
Includes (1) F-300 for 1/16" OD tubing

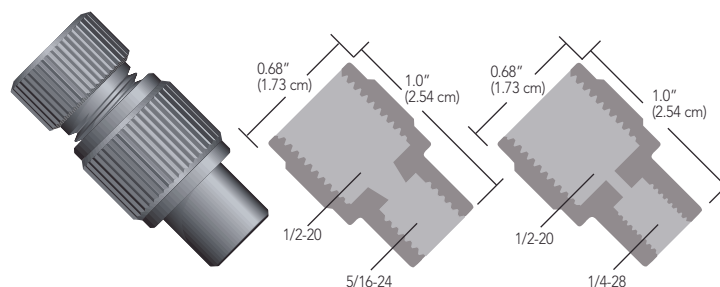

**U-659**  
Tapered thru-hole  
Includes (1) U-650/U-655  
for 1/4" OD tubing

**U-665**  
0.063" (1.60 mm) thru-hole  
Includes (1) U-650/U-655  
for 1/4" OD tubing

## RELATED PRODUCTS

- ▶ Please refer to our Connections Reference Chart on page 35 for assistance with choosing the right product for your needs.
- ▶ Use the Rheodyne® 6000-076 Adapter to connect 1/16" OD tubing to the Rheodyne Preparative-Scale Injector Valve (page 132).

Part No.	Description	Includes	Thru-hole	Swept Volume	Pressure Rating
<b>ENGLISH THREADED ADAPTERS</b>					
<b>6000-076</b>	PEEK Adapter, 5/16-24 C, M to 10-32 C, F	N/A	0.066" (1.70 mm)	49.8 µL	3,000 psi (207 bar)
<b>P-135</b>	PEEK Adapter, 5/16-24 FB, F to 1/4-28 F	N/A	0.080" (2.05 mm)	4.1 µL	1,000 psi (69 bar)
★ <b>P-627</b>	PEEK Adapter, 10-32 C, F to 1/4-28 FB, F	(1) F-300	0.020" (0.50 mm)	0.30 µL	1,000 psi (69 bar)
★ <b>P-681</b>	PCTFE Adapter, 5/16-24 FB, F to 1/4-28 FB, M	N/A	0.125" (3.20 mm)	96.6 µL	1,000 psi (69 bar)
<b>P-684</b>	PCTFE Adapter, 1/2-20 FB, F to 1/4-28 FB, M	N/A	0.130" (3.30 mm)	121.7 µL	250 psi (17 bar)
<b>P-718</b>	PCTFE Adapter, 5/16-24 FB, M to 1/4-28 FB, F	N/A	0.040" (1.00 mm)	10.3 µL	1,000 psi (69 bar)
<b>U-659</b>	PEEK Adapter, 5/16-24 FB, F to 1/2-20 FB, F	(1) XU-655	Tapered*	42.0 µL	250 psi (17 bar)
<b>U-665</b>	PEEK Adapter, 1/2-20 FB, F to 1/4-28 FB, F	(1) XU-655	0.063" (1.60 mm)	6.6 µL	250 psi (17 bar)

F = Female (internal) threads; M = Male (external) threads; C = Coned; FB = Flat-Bottom  
\* Thru-hole tapers from 0.188" (4.80 mm) to 0.125" (3.20 mm).

## English Threaded Adapters, cont.

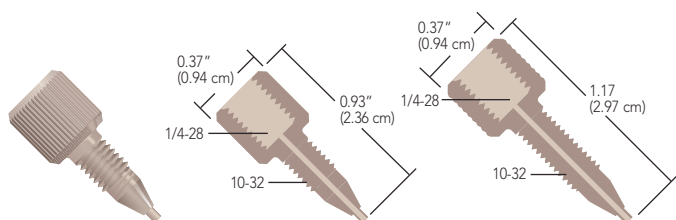

**P-652**  
0.030" (0.75 mm) thru-hole  
Note the new knurled design

**P-654**  
Extra Long, 0.030"  
(0.76 mm) thru-hole

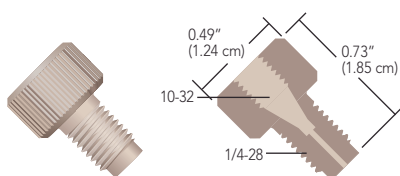

**P-669-01**  
0.040" (1.00 mm) thru-hole

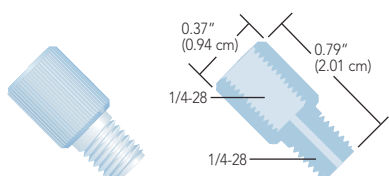

**P-671**  
0.040" (1.00 mm) thru-hole

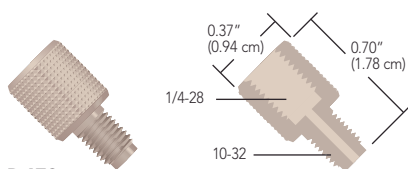

**P-672**  
0.050" (1.25 mm) thru-hole



## APPLICATION NOTE

## Here are application ideas using two of our popular adapters:

- ▶ Many injection valves used in HPLC systems have 10-32 coned ports designed to accept 1/16" OD tubing. However, this may be a problem if large injection volumes are required (in excess of 10 mL). The most popular loops for large volume samples are made from 1/8" OD tubing, making it impossible to connect these larger volume loops to your injection valve. The solution: use our P-654 Adapter and the appropriate fittings for your sample loop. This set-up allows connection of 1/8" OD sample loop leads to your injection valve.
- ▶ Another potential application is connecting tubing to low-pressure solenoid valves with 1/4-28 flat-bottom ports. Most low-pressure valves of this type have very shallow threaded ports, which typically preclude the use of our Flangeless Fittings. However, by first threading our P-671 Adapter into the valve port(s), you can effectively use standard 1/4-28 fittings to connect your tubing into the backside of the adapter port. This also saves "wear and tear" on the threads in the valve ports.

## NOTE

- ▶ When using an adapter with male (external) threads, we recommend you first attach the adapter body into the receiving port, and then connect your tubing and fitting into the head of the adapter body.

## RELATED PRODUCTS

- ▶ You may not need an adapter to connect 1/16" OD tubing into your flat-bottom port. A less expensive alternative is to use a Flangeless Nut and Ferrule starting on page 24 or a Super Flangeless™ Nut and Ferrule starting on page 21. Our Connections Reference chart on page 35 is also a good resource to consult when making connections.

Part No.	Description	Includes	Thru-hole	Swept Volume	Pressure Rating
<b>ENGLISH THREADED ADAPTERS</b>					
★ P-652	PEEK Adapter, 1/4-28 FB, F to 10-32 C, M	N/A	0.030" (0.75 mm)	6.7 µL	1,000 psi (69 bar)
★ P-654	PEEK Adapter, 1/4-28 FB, F to 10-32 C, M, Extra Long	N/A	0.030" (0.75 mm)	9.5 µL	1,000 psi (69 bar)
★ P-669-01	PEEK Adapter, 10-32 C, F to 1/4-28 FB, M	N/A	0.040" (1.00 mm)	6.6 µL	1,000 psi (69 bar)
P-671	PTFE Adapter, 1/4-28 FB, F to 1/4-28 FB, M	N/A	0.040" (1.00 mm)	8.0 µL	1,000 psi (69 bar)
P-672	PEEK Adapter, 1/4-28 FB, F to 10-32 FB, M	N/A	0.050" (1.25 mm)	11.4 µL	1,000 psi (69 bar)

F = Female (internal) threads; M = Male (external) threads; XL = extra long; C = Coned; FB = Flat-Bottom

\* The pressure ratings of these adapters exceed the pressure holding ability of the fittings and tubing used with them.

## Metric Threaded Adapters

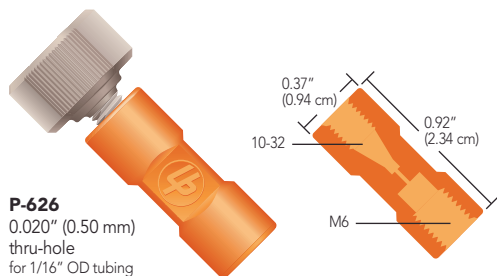

**P-626**  
0.020" (0.50 mm)  
thru-hole  
for 1/16" OD tubing  
Includes (1) F-300

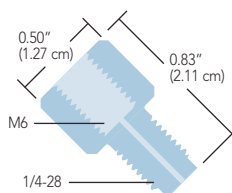

**P-670**  
0.030" (0.75 mm) thru-hole

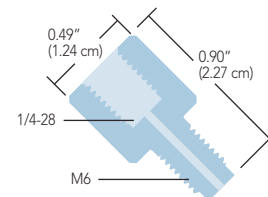

**P-694**  
0.040" (1.00 mm) thru-hole

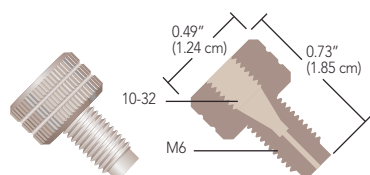

**P-920-01**  
0.040" (1.00 mm) thru-hole

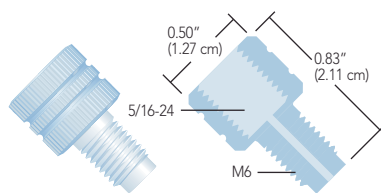

**P-673**  
0.040" (1.00 mm) thru-hole

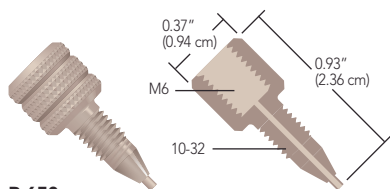

**P-650**  
0.030" (0.75 mm) thru-hole

## RELATED PRODUCTS

- ▶ For an alternative to the Female M6 Adapters presented in the left column of this page, try a P-602 or P-622 Low Pressure Metric Union from page 40, along with the appropriate Metric Flangeless Fittings on page 27.
- ▶ To direct connect your tubing into a flat-bottom port, find the appropriate Flangeless or Super Flangeless™ Fittings on pages 24–27 and 21–23 respectively.
- ▶ Need metric fittings for your connections? See page 27.

Part No.	Description	Includes	Thru-hole	Swept Volume	Pressure Rating
<b>METRIC M6 THREADED ADAPTERS</b>					
<b>P-626</b>	PEEK Adapter, 10-32 C, F to M6 FB, F	(1) F-300	0.020" (0.50 mm)	0.3 µL	1,000 psi (69 bar)
★ <b>P-650</b>	PEEK Adapter, M6 FB, F to 10-32 C, M Standard	N/A	0.030" (0.75 mm)	6.7 µL	1,000 psi (69 bar)
<b>P-670</b>	PCTFE Adapter, M6 FB, F to 1/4-28 FB, M	N/A	0.030" (0.75 mm)	2.6 µL	1,000 psi (69 bar)
<b>P-673</b>	PCTFE Adapter, 5/16-24 FB, F to M6 FB, M	N/A	0.040" (1.00 mm)	9.9 µL	1,000 psi (69 bar)
<b>P-694</b>	PCTFE Adapter, 1/4-28 FB, F to M6 FB, M	N/A	0.040" (1.00 mm)	11.3 µL	1,000 psi (69 bar)
<b>P-920-01</b>	PEEK Adapter, 10-32 C, F to M6 FB, M	N/A	0.040" (1.00 mm)	8.0 µL	1,000 psi (69 bar)

F = Female (internal) threads; M = Male (external) threads; C = Coned; FB = Flat-Bottom

\* The pressure rating of this adapter exceeds the pressure holding ability of the fittings and tubing used with it.



## External National Pipe Thread Adapters

These adapters make connections to female 1/8" and 1/4" National Pipe Thread (NPT) ports.

Manufactured from PEEK polymer by IDEX Health & Science, Upchurch Scientific® NPT Adapters are durable and chemically resistant. We provide versions with either 1/4-28 or 5/16-24 flat-bottom threads, suitable for most low pressure applications.

*Please Note: Wrap the threads on the NPT side of these adapters with thread seal tape (plumber's tape) to ensure a leak-free seal.*

### APPLICATION NOTE

Our U-500 and U-510 NPT Adapters are great for attaching 1/8" OD fluoropolymer sparging lines to sparging gas tank regulating valves. Simply thread the appropriately-sized NPT Adapter into the valve's receiving port and then attach your sparging tubing to the adapter body using the fittings provided.

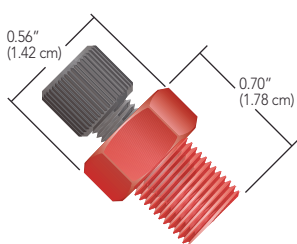

**U-510**  
1/8" NPT to 1/4-28 Flat-Bottom Female Adapter for 1/8" OD tubing  
Includes (1) XP-308 Fitting

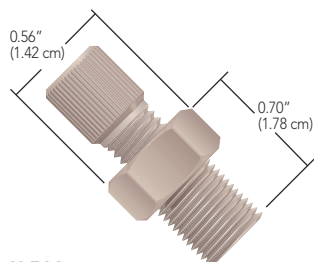

**U-514**  
1/8" NPT to 5/16-24 Flat-Bottom Female Adapter for 3/16" OD tubing  
Includes (1) XP-132 Fitting



### RELATED PRODUCTS

Replacement fittings for these adapters are located on the pages indicated below:

	Page(s)
1/4-28 for 1/8" OD tubing	26
5/16-24 for 1/8" OD tubing	23, 30
5/16-24 for 3/16" OD tubing	30

Other tubing/fitting combinations are available. For more information, please contact your local Distributor or IDEX Health & Science directly.

Part No.	Description	Color	Tubing OD	Includes	Thru-hole	Swept Volume	Pressure Rating
<b>1/8" MALE NPT ADAPTERS</b>							
★ U-510	PEEK 1/8" NPT, M to 1/4-28 FB, F Adapter	Red	1/8"	(1) XP-308	0.062" (1.60 mm)	17.3 µL	500 psi (34 bar)
U-514	PEEK 1/8" NPT, M to 5/16-24 FB, F Adapter	Natural	3/16"	(1) XP-132	0.125" (3.2 mm)	70.4 µL	500 psi (34 bar)
<b>1/4" MALE NPT ADAPTERS</b>							
U-500	PEEK 1/4" NPT, M to 1/4-28 FB, F Adapter	Red	1/8"	(1) XP-308	0.062" (1.60 mm)	17.3 µL	500 psi (34 bar)
U-504	PEEK 1/4" NPT, M to 5/16-24 FB, F Adapter	Natural	3/16"	(1) XP-132	0.125" (3.2 mm)	70.4 µL	500 psi (34 bar)

F = Female (internal) threads; M = Male (external) threads; FB = Flat-Bottom

## MicroTight Adapters

- ▶ Convenient adapters for common 1/16" OD to capillary tubing
- ▶ Direct connect to 1/32" OD or 360 µm OD tubing options available
- ▶ VHP adapters pressure rated to 12,000 psi (828 bar)

Create a true zero dead volume (ZDV) connection between 1/16" OD tubing and capillary tubing with these Upchurch Scientific® MicroTight Adapters.

For Very High Pressure applications the UH-630 will connect 1/16" OD to 1/32" OD tubing in an inline true ZDV connection with the ability to withstand 12,000 psi (828 bar)! The materials of construction also allow this product to be used up to 200 °C, which reduces the pressure rating to 8,000 psi (552 bar). For more information on the fittings used with the VHP adapter, please see page 9.

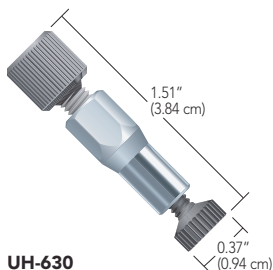

**UH-630**  
VHP MicroTight Adapter  
for 1/16" and 1/32" OD tubing  
with fittings included



**UH-634**  
VHP MicroTight Adapter  
for 1/16" and 360 µm OD tubing  
with fittings included

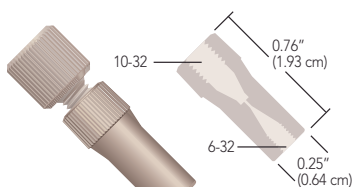

**P-770**  
MicroTight ZDV Adapter  
for 1/16" OD to MicroTight Sleeves  
with fittings included



**1958-01**  
VHP MicroTight Adapter  
10-32 Coned for 1/16" OD tubing  
and M4x0.7 for 1/32" OD tubing

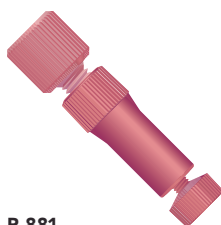

**P-881**  
MicroTight ZDV Adapter  
for 1/16" to 1/32" OD tubing  
with fittings included



**P-882**  
MicroTight ZDV Adapter  
for 1/16" to 360 µm OD tubing  
with fittings included

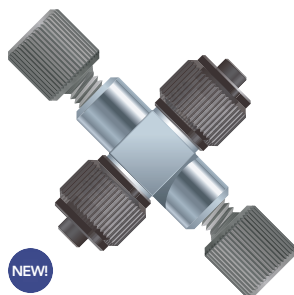

**UH-906**  
VHP MicroTight Adapting Cross  
10-32 Coned for 1/16" OD tubing and  
5/16-24 Coned for 360 µm OD tubing

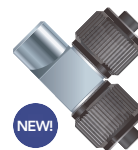

**UH-753**  
VHP MicroTight  
Adapting Tee  
360 µm (2 ports) to  
10-32 C for 1/16" OD  
tubing (1 port)



**UH-631-01**  
VHP MicroTight  
Adapter  
10-32 Coned for  
1/16" OD tubing  
and 6-40 Coned for  
1/32" OD tubing  
fittings not included

### NOTE

While many 10-32 coned fittings are interchangeable, coned fittings using different threads are generally not interchangeable. As such, IDEX Health & Science recommends that only the style of coned fittings that accompanies these connectors be used for replacements.

### RELATED PRODUCTS

- ▶ Replacement 6-32 fittings are on page 54.
- ▶ Replacement F-120 style nuts are on page 11 (when ordering, replace the "x" with an "R" or "B" to order either red or blue fittings).
- ▶ Use this list to find micro flow products outside this chapter.

	Page
360 µm, 510 µm (0.020"), and 1/32" OD PEEK Tubing	67
360 µm OD Fused Silica Tubing	67
1/16" and 1/32" OD PEEKsil™ Tubing	68
1/32" OD FEP Tubing	71
360 µm OD High Purity PFA Tubing	72
510 µm (0.020") and 1/32" OD Stainless Steel Tubing	64
Polymer Capillary and Fused Silica Tubing Cutters	74
Rheodyne® MX Series II™ Injection and Switching Valves	130
Rheodyne Manual Injection Valves	132
Micro Injection Port Adapters	143
Micro-Splitter Valves	146
Micro-Metering Valves	147
Microbore Guard Column	172
Ultra-Low Volume Back-Pressure Regulators	154
Nonmetallic 10-32 Micro-Volume Inline Check Valve	149
Ismatec® Peristaltic Tubing Pumps	92

Part No.	Description	Threads	Includes	Color	Swept Volume	Pressure Rating
<b>MICROTIGHT ADAPTERS</b>						
★ P-770	PEEK Micro Adapter, True ZDV, for 1/16" OD Tubing to MicroTight Tubing Sleeve	10-32 C to 6-32 C	(1) F-120, (1) F-125, (1) P-554	Natural	N/A	4,000 psi (276 bar)
★ P-881	PEEK Micro Adapter, True ZDV, for 1/16" to 1/32" OD Tubing	10-32 C to 6-32 C	(1) F-120R, (1) F-126S, (1) P-554	Red	N/A	5,000 psi (345 bar)
★ P-882	PEEK Micro Adapter, True ZDV, for 1/16" to 360 µm OD Tubing	10-32 C to 6-32 C	(1) F-120B, (1) F-124S, (1) P-554	Blue	N/A	5,000 psi (345 bar)
NEW! UH-630	Stainless Steel VHP Micro Adapter, for 1/16" to 1/32" OD Tubing	10-32 C to 6-32 C	(1) PK-120BLK, (1) PK-126, (1) P-554	SST/Black	N/A	12,000 psi (827 bar)
NEW! UH-634	Stainless Steel VHP Micro Adapter, for 1/16" to 360 µm OD Tubing	10-32 C to 6-32 C	(1) PK-120BLK, (1) PK-124, (1) P-554	SST/Black	N/A	12,000 psi (827 bar)
NEW! UH-753	Stainless Steel VHP Micro Adapting Tee, for 1/16" to 360 µm OD Tubing	10-32 C to 5/16-24 C	(2) P-416BLK, (2) PK-152	SST/Black	152 nL	15,000 psi (1,035 bar)*
NEW! 1958-01	Stainless Steel VHP Micro Adapter, for 1/16" to 1/32" OD Tubing	10-32 C to M4x0.7 C	N/A	SST	16 nL	30,000 psi (2,070 bar)*
NEW! UH-631-01	Stainless Steel VHP Micro Adapter, for 1/16" to 1/32" OD Tubing	10-32 C to 6-40 C	N/A	SST	13 nL	30,000 psi (2,070 bar)*
NEW! UH-906	Stainless Steel VHP Micro Adapting Cross, for 1/16" to 360 µm OD Tubing	10-32 C to 5/16-24 C	(2) PK-120BLK, (2) P-416BLK, (2) PK-152	SST/Black	0.11 µL	15,000 psi (1,035 bar)*

### REPLACEMENT GAUGE PLUGS (TO ACHIEVE TRUE ZDV CONNECTIONS WITH THE ABOVE ADAPTERS)

P-554	Delrin® Gauge Plug	10-32 C		White	N/A	N/A
-------	--------------------	---------	--	-------	-----	-----

C = Coned

\* Pressure rating depends upon the fitting used.

## NanoPort Assemblies

- ▶ For lab-on-a-chip applications
- ▶ Options to connect 360 µm, MicroTight® tubing sleeves, 1/32" OD or 1/16" OD tubing
- ▶ Wetted materials: PEEK and perfluoroelastomer

Upchurch Scientific® NanoPort Assemblies provide consistent fluid connections for chip-based analyses. Once attached, NanoPort connections can withstand pressures to 1,000 psi (69 bar).\* NanoPorts will adhere to silicon, quartz, glass and some polymers.

All NanoPort components are made of inert, biocompatible PEEK polymer (nuts and ports) and Perlast® perfluoroelastomer (ferrules and gaskets). These products bond easily to chip surfaces with the provided Preformed Adhesive Rings (see Application Note below). Their unique design also prevents adhesive contamination of the fluid path. And NanoPort connections add no additional volume to the fluid path, virtually eliminating dead volume traditionally associated with chip-based fluid connections.

Our NanoPort Reservoir Assembly is designed for open well applications, such as CE.

*\*Except the N-333 NanoPort Assembly, which is rated to 500 psi (34 bar).*

### APPLICATION NOTE

#### NanoPort Adhesive Cure Requirements

- ▶ Preformed Adhesive Rings (included with each order).

Cure Temperature	Cure Time
165–177 °C (330–350 °F)	1 hour

- ▶ Place clamped Ports in oven at a temperature of 165–177 °C (330–350 °F) for one hour to develop a complete bond between the Port and the substrate.
- ▶ Due to differences in thermal expansion rates, IDEX Health & Science does not recommend the use of the Preformed Adhesive Rings when connecting NanoPorts to metal substrates. For information on this, for information regarding the adherence of NanoPorts to other polymer substrates, or for information on other adhesive options, please contact us or your authorized Distributor directly.

#### NanoPort Reservoir Applications

- ▶ Sample reservoir.
- ▶ Open wells for capillary electrophoresis.
- ▶ Syringe injection or flushing/priming, using our P-604 Luer Adapter, page 55, and luer syringe (such as our B-310) on page 55.

#### 6-32 Flat-Bottom Assemblies

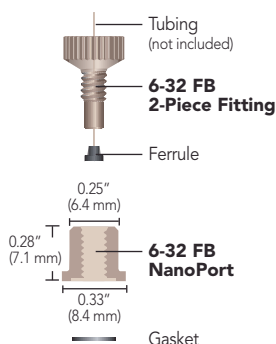

#### 6-32 Coned Assemblies

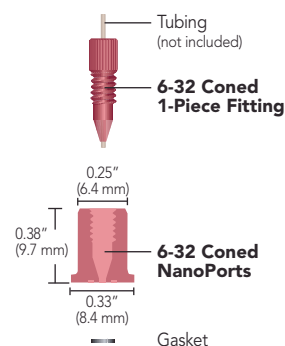

#### Reservoir Assembly

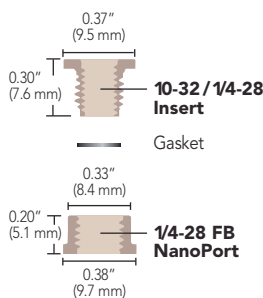

#### 10-32 Coned Assembly

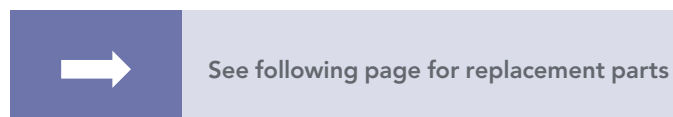
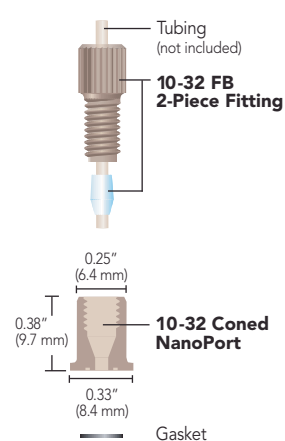

Part No.	Nut	Ferrule	For Chip Hole (dia. x depth)	For Tubing OD	Qty.
<b>NANOPORT ASSEMBLIES</b>					
<b>6-32 Flat-Bottom NanoPort Assemblies</b>					
N-121S	F-123S	N-123-04	0.04" x 0.04" (1.0 mm x 1.0 mm)	360 µm	ea.
N-123H	F-123H	N-123-03	0.04" (1.0 mm) dia. or less	360 µm	ea.
N-123S	F-123S	N-123-03	0.04" (1.0 mm) dia. or less	360 µm	ea.
<b>6-32 Coned NanoPort Assemblies</b>					
N-124S	F-124S	None	Up to 0.063" (1.6 mm)	360 µm	ea.
N-125S	F-125	None	Up to 0.063" (1.6 mm)	70–520 µm <sup>1</sup>	ea.
N-126H	F-126H	None	Up to 0.063" (1.6 mm)	1/32"	ea.
N-126S	F-126S	None	Up to 0.063" (1.6 mm)	1/32"	ea.
<b>10-32 Coned NanoPort Assembly</b>					
★ N-333	F-333N	F-142N	Up to 0.063" (1.6 mm)	1/16"	ea.
<b>NanoPort Reservoir Assembly</b>					
N-131	80 µL Reservoir with Insert				ea.

<sup>1</sup> Designed to use our MicroTight® Tubing Sleeves (page 19) to connect tubing OD sizes from 70–520 µm.

## NanoPort Assemblies (cont.)



### NOTE

To select the appropriate NanoPort assembly you will need to consider:

- ▶ Size of tubing you are connecting
- ▶ Dimensions of the chip hole
- ▶ Fitting style (one-piece or two-piece fittings)
- ▶ Nut head style (standard or headless nut)

*Please Note: Each NanoPort Assembly includes a fitting (one- or two-piece), a NanoPort, gasket, a 2-pack of preformed adhesive rings, and a clamp for holding the port in place while the adhesive cures.*



Full NanoPort Assemblies can be found on the previous page

Part No.	Description	Threads	For Chip Hole	Tubing OD	Qty.
<b>NANOPORT REPLACEMENT PARTS</b>					
<b>Fittings</b>					
F-123Hx	Headless Nuts	6-32 FB	N/A	360 µm	10-pk
F-123Sx	Standard Head Nuts	6-32 FB	N/A	360 µm	10-pk
F-124Sx	Standard Head Fittings	6-32 C	N/A	360 µm	10-pk
★ F-125x	Standard Head Fittings	6-32 C	N/A	70–520 µm <sup>1</sup>	10-pk
F-126Hx	Headless Fittings	6-32 C	N/A	1/32"	10-pk
F-126Sx	Standard Head Fittings	6-32 C	N/A	1/32"	10-pk
F-333Nx	Headless Fittings	10-32 C	Up to 0.063" (1.6 mm)	1/16"	10-pk
F-142Nx	Ferrules	10-32 C	Up to 0.063" (1.6 mm)	1/16"	10-pk
★ N-123-03x	Ferrules	6-32 FB	0.04" (1.0 mm) dia. or less	360 µm	10-pk
★ N-123-04x	Ferrules	6-32 FB	0.04" x 0.04" (1.0 mm x 1.0 mm)	360 µm	10-pk
N-123-05x	Ferrules	6-32 FB	0.04" x 0.06" (1.0 mm x 1.5 mm)	360 µm	10-pk
<b>Gaskets</b>					
N-123-02	Gasket, For all assemblies except 6-32 Coned Assemblies		N/A	N/A	ea.
N-124-02	Gasket, For 6-32 Coned Assemblies		N/A	N/A	ea.
<b>Adhesives and Clamp</b>					
N-006	Clamp		N/A	N/A	ea.
★ N-100-01	Preformed Adhesive Rings		N/A	N/A	2-pk

<sup>1</sup> Designed to use our MicroTight® Tubing Sleeves (page 19) to connect tubing OD sizes from 70–520 µm.  
Abbreviation Definitions: FB = Flat-Bottom; C = Coned; N/A = Not Applicable

## Quick Connect Luer Adapters

- ▶ Delrin®, polypropylene, ETFE, or PEEK Versions
- ▶ Adapts luers to 1/4-28, 10-32, 5/16-24, or M6 threaded ports

These luer adapters were designed to work in a variety of applications. By connecting any male luer to any female luer, you can create your own quick connect union or adapter. Each Upchurch Scientific® Quick Connect Luer Adapter conforms to ISO requirements for medical luer taper configuration and performance (45 psi/3.1 bar).

Find fittings to connect tubing to the threaded ports of these adapters in the Fittings chapter, starting on page 4.

*Please Note: Our Female Quick Connect Luer Adapters can be used with any of the Male Luers on this page, i.e., those with and without lock hubs.*

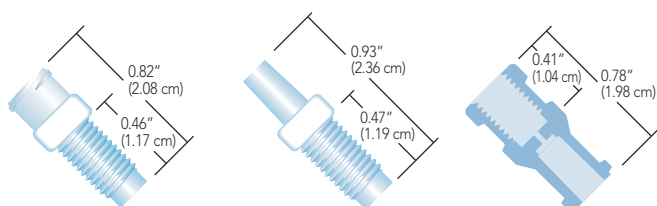

**P-604, P-618, P-624**  
Female Luer to 1/4-28 Male  
(luer end of P-604 different than shown)

**P-619, P-625**  
Male Luer to 1/4-28 Male

**P-628**  
Female Luer to 1/4-28 Female

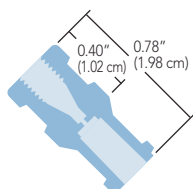

**P-629**  
Female Luer to 10-32 Female

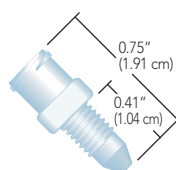

**P-642**  
Female Luer to 10-32 Male



**P-719**  
Female Luer to 10-32 Male

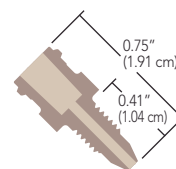

**P-655, P-675**  
Male Luer to 1/4-28 Female

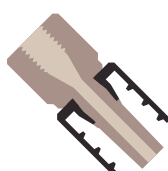

**P-656**  
Male Luer to 10-32 Female

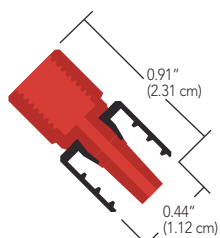

**P-657, P-677**  
Male Luer to M6 Female

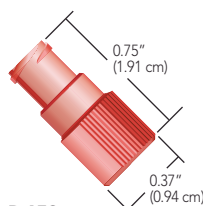

**P-658, P-678**  
Female Luer to 1/4-28 Female



**P-659**  
Female Luer to 10-32 Female

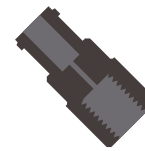

**P-660, P-680**  
Female Luer to M6 Female

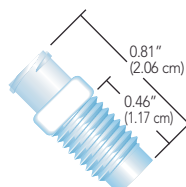

**P-661**  
Female Luer to 5/16-24 Male

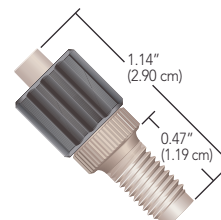

**P-683**  
Male Luer to 1/4-28 Male

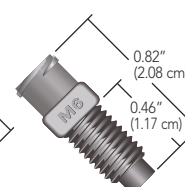

**P-686**  
Female Luer to M6 Male

### APPLICATION NOTE

- ▶ Our A-626 Bottle Cap Plug (page 159) can be used to plug any of the female luer adapters on this page.
- ▶ To prevent a chemical spill when disconnecting your solvent reservoir tubing from the pump, try our Quick-Stop Luer Check Valve on page 151.
- ▶ To economically prime an HPLC pump, simply remove the 10-32 fitting on the outlet check valve (standard on most models), insert a P-642 luer adapter, attach a syringe (such as our B-310) and draw the mobile phase through the pump head.

Part No.	Description	Body Material	Lock Hub Material	Thru-hole
<b>QUICK CONNECT LUER ADAPTERS</b>				
P-604	F Luer to 1/4-28 FB, M	Nat. Delrin	N/A	0.05" (1.3 mm)
P-618	F Luer to 1/4-28 FB, M	Nat. PP	N/A	0.05" (1.3 mm)
P-619	M Luer to 1/4-28 FB, M	Nat. PP	None *	0.05" (1.3 mm)
* P-624	F Luer to 1/4-28 FB, M	Nat. ETFE	N/A	0.05" (1.3 mm)
* P-625	M Luer to 1/4-28 FB, M	Nat. ETFE	None *	0.04" (1.0 mm)
* P-628	F Luer to 1/4-28 FB, F	Nat. ETFE	N/A	0.04" (1.0 mm)
P-629	F Luer to 10-32 C, F	Nat. ETFE	N/A	0.04" (1.0 mm)
* P-642	F Luer to 10-32 C, M	Nat. ETFE	N/A	0.05" (1.3 mm)
* P-655	M Luer to 1/4-28 FB, F	Red PEEK	Black PEEK	0.04" (1.3 mm)
* P-656	M Luer to 10-32 C, F	Nat. PEEK	Black PEEK	0.05" (1.3 mm)
P-657	M Luer to M6 FB, F	Black PEEK	Black PEEK	0.05" (1.3 mm)
* P-658	F Luer to 1/4-28 FB, F	Red PEEK	N/A	0.05" (1.3 mm)
* P-659	F Luer to 10-32 C, F	Nat. PEEK	N/A	0.05" (1.3 mm)
P-660	F Luer to M6 FB, F	Black PEEK	N/A	0.05" (1.3 mm)
P-661	F Luer to 5/16-24 FB, M	Nat. ETFE	N/A	0.05" (1.3 mm)
* P-675	M Luer to 1/4-28 FB, F	Red ETFE	Natural PP	0.05" (1.3 mm)
* P-677	M Luer to M6 FB, F	Black ETFE	Natural PP	0.05" (1.3 mm)
* P-678	F Luer to 1/4-28 FB, F	Red ETFE	N/A	0.05" (1.3 mm)
P-680	F Luer to M6 FB, F	Black ETFE	N/A	0.05" (1.3 mm)
* P-683	M Luer to 1/4-28 FB, M	Nat. PEEK	Black PEEK	0.04" (1.0 mm)
* P-686	F Luer to M6 FB, M	Black ETFE	N/A	0.05" (1.3 mm)
<b>NEW!</b> P-719	F Luer to 10-32 C, M	Nat. PEEK	N/A	0.05" (1.3 mm)

### SYRINGE WITH MALE LUER LOCK

<b>B-310</b>	10 cc Disposable Luer-Lock Syringe For use with any Female Luer Adapter	0.05" (1.3 mm)
--------------	--	----------------

F = Female (internal) threads; M = Male (external) threads; Nat. = Natural; N/A = Not Applicable; PP = Polypropylene; FB = Flat-Bottom; C = Coned  
\* Slip-type male luer.

## LuerTight™ Fittings

- ▶ Luer fittings for fluoropolymer tubing
- ▶ Quick disconnect and barbless
- ▶ For 1/16" and 1/8" OD tubing

Upchurch Scientific® LuerTight fittings are specifically designed to connect fluoropolymer tubing without barbs or nuts! By integrating ferrules into the luer bodies, LuerTights will reliably hold your tubing in place while giving you the convenience of a luer connection. An inline set of LuerTight fittings provides a quick and easy disconnection option. LuerTight connections are also less bulky and more economical than nut-to-luer style fittings.

The bodies of these products are manufactured from polypropylene and the ferrules, where used, are made of ETFE.

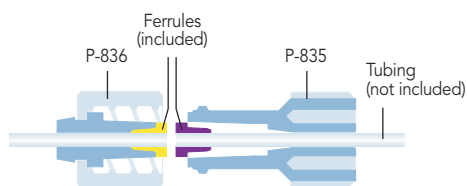

**P-837**  
LuerTight Fittings System  
for 1/16" OD tubing

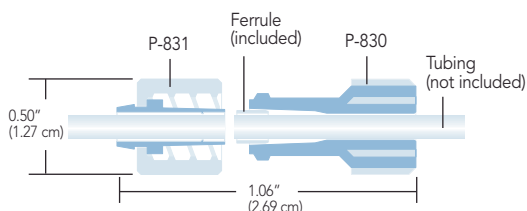

**P-838**  
LuerTight Fittings System  
for 1/8" OD tubing

### NOTE

LuerTight fittings are designed to be used exclusively within the LuerTight family. Combining LuerTight fittings with non-LuerTight luer products may result in a poor connection.

### ORDER ONLINE

Part No.	Description	Includes	Thru-hole	Pressure Rating
<b>LUERTIGHT FITTINGS SYSTEMS</b>				
★ P-837	LuerTight System for 1/16" OD Tubing	(1) P-835, (1) P-836, (1) P-830T	N/A	100 psi (7 bar)
P-838	LuerTight System for 1/8" OD Tubing	(1) P-830, (1) P-831, (1) P-830T	N/A	100 psi (7 bar)
<b>LUERTIGHT FITTING COMPONENTS</b>				
P-830	Female Fitting for 1/8" OD Tubing	(1) Ferrule	N/A	N/A
P-830T	Set Plug to swage Ferrules into P-835 and P-830	N/A	N/A	N/A
P-831	Male Fitting for 1/8" OD Tubing	No Ferrule Required	N/A	N/A
P-835	Female Fitting for 1/16" OD Tubing	(1) Ferrule	N/A	N/A
P-836	Male Fitting for 1/16" OD Tubing	(1) Ferrule	N/A	N/A
<b>LUER-TO-MICROTIGHT ADAPTER</b>				
★ P-662	Luer-to-MicroTight Adapter	(1) F-152, (1) P-416	0.006" (0.150 mm)	45 psi (2.4 bar)

*Female = internal receiving luer pocket; Male = external luer nose (surrounded by internally-threaded locking ring)*



## Luer-To-MicroTight® Adapter

- ▶ Easily connect 360 µm OD tubing to a syringe

The Upchurch Scientific Luer-to-MicroTight Adapter is ideal for infusing sample into lab-on-a-chip devices. This product is made entirely of biocompatible PEEK polymer and introduces only 14 nL of additional volume to the flow path. Use it to directly connect a luer-tip syringe or other product that terminates with a standard male luer to 360 µm OD capillary tubing without tubing sleeves (see photo). MicroTight Fittings are included.



*P-662 Luer-to-MicroTight Adapter, shown with a B-310 Syringe (page 55) and PEEK capillary tubing (page 67), not included.*

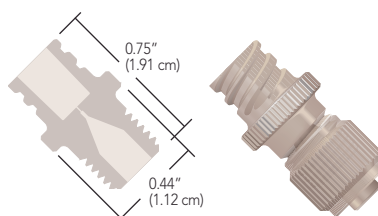

**P-662**  
Luer-To-MicroTight Adapter  
for Luer to 360 µm OD tubing  
with fittings included





## Swivel Barb Adapters

- ▶ Barb connection spins freely from the nut to prevent twist during installation
- ▶ Manufactured from polypropylene

The new Swivel Barb Adapters from Upchurch Scientific® are made up of two captive pieces acting as a one-piece fitting for ease of use. Manufactured from polypropylene and available in three barb sizes, the Swivel Barb will facilitate connection between flexible tubing to a 1/4-28 flat-bottom port. The barbed insert spins freely from the threaded nut in order to prevent the tubing from twisting during installation.

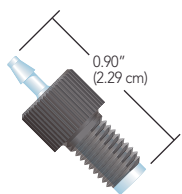

**D-646**  
1/4-28 to 1/16" ID tubing

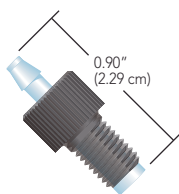

**D-647**  
1/4-28 to 3/32" ID tubing

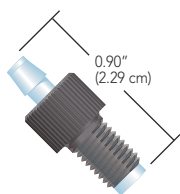

**D-648**  
1/4-28 to 1/8" ID tubing



## Thread to Barbed Adapters

- ▶ Three barb sizes, for 1/16", 1/8", and 3/16" ID flexible tubing
- ▶ Adapt to 1/4-28 flat-bottom, 5/16-24 flat-bottom, or 10-32 coned receiving ports

These Upchurch Scientific adapters make it easy to connect flexible tubing to any standard 1/4-28 flat-bottom or 10-32 coned receiving port. Simply thread the adapter into a receiving port and slip tubing over the barbed stem to create a reliable low pressure connection.

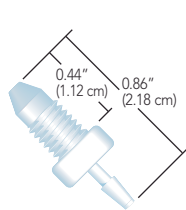

**P-663**  
10-32 to 1/16" ID tubing

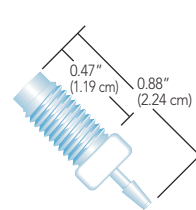

**P-646**  
1/4-28 to 1/16" ID tubing

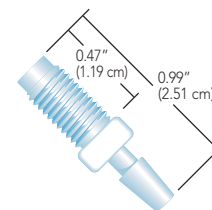

**P-647**  
1/4-28 to 1/8" ID tubing

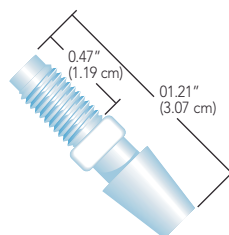

**P-648**  
1/4-28 to 3/16" ID tubing

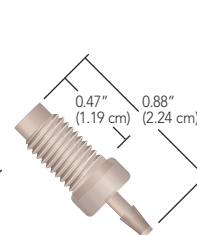

**P-668**  
1/4-28 to 1/16" ID tubing

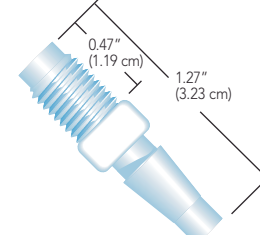

**P-689**  
5/16-24 to 3/16" ID tubing

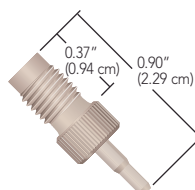

**P-692**  
1/4-28 to 0.020"–1/32" ID tubing

## RELATED PRODUCTS

- ▶ To connect low pressure fluoropolymer tubing, try the LuerTight™ Adapters on page 56.
- ▶ To connect peristaltic tubing to low pressure fluoropolymer tubing, see page 60.
- ▶ For peristaltic tubing, see pages 75–89.

Part No.	Description	Material	Threads	Thru-hole
<b>SWIVEL BARB ADAPTERS</b>				
D-646	Swivel Barb Adapter, 1/16" (1.55 mm) ID Tubing	Polypropylene	1/4-28 Flat-Bottom	0.03" (0.75 mm)
D-647	Swivel Barb Adapter, 3/32" (2.40 mm) ID Tubing	Polypropylene	1/4-28 Flat-Bottom	0.056" (1.5 mm)
D-648	Swivel Barb Adapter, 1/8" (3.20 mm) ID Tubing	Polypropylene	1/4-28 Flat-Bottom	0.08" (2.0 mm)
<b>THREAD TO BARBED ADAPTERS</b>				
★ P-663	Barb Adapter, 1/16" (1.55 mm) ID Tubing	ETFE	10-32 Coned	0.04" (1.0 mm)
★ P-646	Barb Adapter, 1/16" (1.55 mm) ID Tubing	ETFE	1/4-28 Flat-Bottom	0.04" (1.0 mm)
★ P-647	Barb Adapter, 1/8" (3.20 mm) ID Tubing	ETFE	1/4-28 Flat-Bottom	0.08" (2.0 mm)
P-648	Barb Adapter, 3/16" (4.75 mm) ID Tubing	ETFE	1/4-28 Flat-Bottom	0.10" (2.5 mm)
★ P-668	Barb Adapter, 1/16" (1.55 mm) ID Tubing	PEEK	1/4-28 Flat-Bottom	0.04" (1.0 mm)
P-689	Barb Adapter, 3/16" (4.75 mm) ID Tubing	ETFE	5/16-24 Flat-Bottom	0.10" (2.5 mm)
P-692	Barb Adapter, 0.020" to 1/32" (0.50 to 0.80 mm) ID Tubing	PEEK	1/4-28 Flat-Bottom	0.02" (0.5 mm)



## Barbed Adapters

- ▶ Adapters on this page feature various luer to barb adaptations
- ▶ Adapters on the next page feature a variety of barb-to-barb connectors

Use these barbed adapters to connect peristaltic-type flexible tubing for general, low pressure applications, such as plumbing Ismatec® Peristaltic Pumps (listed on pages 92–108).

The polypropylene used to manufacture the majority of these products is a Class VI material. Due to the low melt point of polypropylene (PP), these adapters are not autoclavable, however, they can be sterilized via gamma radiation. There are also Barb to Female Luer-Lock connectors available from ETFE, which has superior solvent resistance and a higher temperature rating (80 °C).

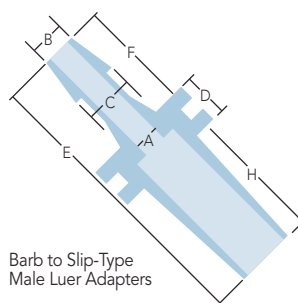

Barb to Slip-Type  
Male Luer Adapters

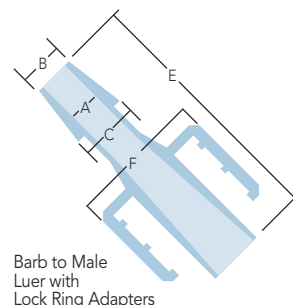

Barb to Male  
Luer with  
Lock Ring Adapters

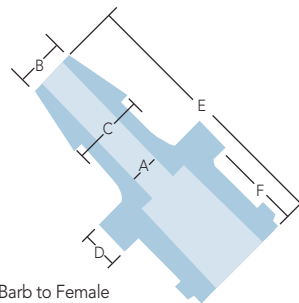

Barb to Female  
Luer-Lock Connectors

Part No.	Description	Material
<b>BARB TO SLIP-TYPE MALE LUER ADAPTERS (10-PK)</b>		
<b>P-854x</b>	Male Luers (Slip-type) for use with 1/16" ID (1.55 mm) Tubing A=0.046" B=0.064" C=0.090" D=0.129" E=0.711" F=0.198" H=0.384"	PP
<i>These slip-type male luer fittings are for use in systems for which luer lock rings are not desired.</i>		
<b>BARB TO MALE LUER WITH LOCK RING ADAPTERS (10-PK)</b>		
<b>P-850x</b>	Male Luers with Lock Ring for use with 1/16" ID (1.55 mm) Tubing A=0.049" B=0.065" C=0.090" E=0.583" F=0.434"	PP
<b>P-851x</b>	Male Luers with Lock Ring for use with 3/32" ID (2.40 mm) Tubing A=0.071" B=0.100" C=0.139" E=0.681" F=0.436"	PP
<b>P-852x</b>	Male Luers with Lock Ring for use with 1/8" ID (3.20 mm) Tubing A=0.099" B=0.132" C=0.184" E=0.777" F=0.436"	PP
<b>BARB TO FEMALE LUER-LOCK CONNECTORS (10-PK)</b>		
<b>P-857x</b>	Female Luer Connectors for use with 1/16" ID (1.55 mm) Tubing A=0.030" B=0.063" C=0.106" D=0.100" E=0.598" F=0.253"	PP
<b>P-858x</b>	Female Luer Connectors for use with 3/32" ID (2.40 mm) Tubing A=0.056" B=0.102" C=0.145" D=0.100" E=0.648" F=0.253"	PP
<b>P-859x</b>	Female Luer Connectors for use with 1/8" ID (3.20 mm) Tubing A=0.080" B=0.135" C=0.187" D=0.100" E=0.733" F=0.253"	PP
<b>P-870</b>	For use with 1/16" (1.55 mm) ID Tubing A=0.030" B=0.063" C=0.106" D=0.100" E=0.598" F=0.253"	ETFE
<b>P-872</b>	For use with 1/8" (3.20 mm) ID Tubing A=0.080" B=0.137" C=0.187" D=0.100" E=0.733" F=0.253"	ETFE

An "x" in the product part number designates "10-pk."

## Barbed Connectors

- ▶ Specifically designed for Ismatec® pump tubing
- ▶ Wide variety of unions, adapters and multi-port connectors in multiple material choices

There are several Ismatec connectors for connecting multiple pieces of peristaltic tubing. Reference the tubing size of the barb in the tables below to select from unions (to connect same tubing size), reducers (to connect two different tubing sizes) in both straight, tee, Y, elbow and cross configurations.

For very small peristaltic tubing, steel connectors are available to couple two pieces of the same size tubing together. Match the OD of the steel tubing connector to be slightly larger than the ID of the peristaltic tubing.

### Standard Tube Connectors in Plastic



Type 1      Type 2      Type 3

Part No.	Tubing ID	Material	Qty.
<b>STANDARD TUBE CONNECTORS IN PLASTIC</b>			
<b>Type 1</b>			
P-801x	0.06" (1.5 mm)	Polypropylene	10-pk
ISM557A	0.10" (2.5 mm)	Polypropylene	10-pk
P-802x	0.12" (3.0 mm)	Polypropylene	10-pk
ISM559	0.16" (4.0 mm)	Nylon	10-pk
ISM560	0.20" (5.0 mm)	Nylon	10-pk
ISM561	0.24" (6.0 mm)	Nylon	10-pk
ISM562	0.31" (8.0 mm)	Nylon	10-pk
ISM563	0.40" (10.0 mm)	Nylon	10-pk
ISM564	0.47" (12.0 mm)	Nylon	10-pk
ISM565	0.51" (13.0 mm)	Nylon	10-pk
ISM566	0.55" (14.0 mm)	Nylon	10-pk
ISM567	0.63" (16.0 mm)	Nylon	10-pk
<b>Type 2</b>			
ISM693A	0.06" (1.5 mm)	Polypropylene	10-pk
ISM694	0.10" (2.5 mm)	Polypropylene	10-pk
ISM510	0.12" (3.0 mm)	Polypropylene	10-pk
ISM511	0.16" (4.0 mm)	Nylon	10-pk
ISM512	0.20" (5.0 mm)	Nylon	10-pk
ISM513	0.24" (6.0 mm)	Nylon	10-pk
ISM514	0.28" (7.0 mm)	Nylon	10-pk
ISM515	0.31" (8.0 mm)	Nylon	10-pk
ISM516	0.40" (10.0 mm)	Nylon	10-pk
<b>Type 3</b>			
P-860x	0.06" (1.5 mm)	Polypropylene	10-pk
P-861x	0.10" (2.5 mm)	Polypropylene	10-pk
ISM524	0.12" (3.0 mm)	Polypropylene	10-pk
ISM525	0.16" (4.0 mm)	Polypropylene	10-pk
ISM526	0.20" (5.0 mm)	Polypropylene	10-pk
ISM527	0.24" (6.0 mm)	Polypropylene	10-pk
P-862x	0.12" (3.0 mm)	Polypropylene	10-pk
P-863x	0.18" (4.8 mm)	Polypropylene	10-pk
P-864x	0.25" (6.4 mm)	Polypropylene	10-pk
ISM528	0.31" (8.0 mm)	Polypropylene	10-pk
ISM529	0.40" (10.0 mm)	Polypropylene	10-pk
ISM530	0.47" (12.0 mm)	Polypropylene	10-pk

### Reducer Tube Connectors in Plastic



Type 6      Type 7      Type 8

### Steel 18/8 Standard Tube Connectors



Part No.	Tubing ID	Material	Qty.		
<b>REDUCER TUBE CONNECTORS IN PLASTIC</b>					
<b>Type 6</b>					
	<b>A</b>	<b>B</b>			
ISM569A	0.06" (1.5 mm)	0.10" (2.5 mm)	Polypropylene 10-pk		
ISM570A	0.06" (1.5 mm)	0.12" (3.0 mm)	Polypropylene 10-pk		
ISM571A	0.10" (2.5 mm)	0.12" (3.0 mm)	Polypropylene 10-pk		
ISM572	0.12" (3.0 mm)	0.16" (4.0 mm)	Nylon 10-pk		
ISM573A	0.16" (4.0 mm)	0.24" (6.0 mm)	Nylon 10-pk		
ISM574	0.16" (4.0 mm)	0.31" (8.0 mm)	Nylon 10-pk		
ISM575	0.24" (6.0 mm)	0.31" (8.0 mm)	Nylon 10-pk		
ISM576	0.24" (6.0 mm)	0.40" (10.0 mm)	Nylon 10-pk		
ISM577	0.31" (8.0 mm)	0.40" (10.0 mm)	Nylon 10-pk		
ISM578	0.31" (8.0 mm)	0.47" (12.0 mm)	Nylon 10-pk		
ISM579	0.40" (10.0 mm)	0.47" (12.0 mm)	Nylon 10-pk		
<b>Type 7</b>					
	<b>A</b>	<b>B</b>			
ISM538	0.12" (3.0 mm)	0.16" (4.0 mm)	Polypropylene 10-pk		
ISM539	0.16" (4.0 mm)	0.24" (6.0 mm)	Polypropylene 10-pk		
ISM540	0.24" (6.0 mm)	0.16" (4.0 mm)	Polypropylene 10-pk		
ISM541	0.31" (8.0 mm)	0.16" (4.0 mm)	Polypropylene 10-pk		
ISM542	0.31" (8.0 mm)	0.24" (6.0 mm)	Polypropylene 10-pk		
ISM544	0.40" (10.0 mm)	0.24" (6.0 mm)	Polypropylene 10-pk		
ISM545	0.40" (10.0 mm)	0.31" (8.0 mm)	Polypropylene 10-pk		
ISM546	0.40" (10.0 mm)	0.51" (13.0 mm)	Polypropylene 10-pk		
ISM547	0.47" (12.0 mm)	0.31" (8.0 mm)	Polypropylene 10-pk		
<b>Type 8</b>					
	<b>A</b>	<b>B</b>			
ISM553	0.16" (4.0 mm)	0.24" (6.0 mm)	Polypropylene 10-pk		
ISM554	0.24" (6.0 mm)	0.31" (8.0 mm)	Polypropylene 10-pk		
<b>STEEL 18/8 STANDARD TUBE CONNECTORS</b>					
Part No.	Tubing ID	Tubing OD	Connector Length	Material	Qty.
ISM580	0.01" (0.30 mm)	0.02" (0.63 mm)	0.59" (15.0 mm)	SST	6-pk
ISM581	0.02" (0.58 mm)	0.04" (0.90 mm)	0.59" (15.0 mm)	SST	6-pk
ISM582	0.02" (0.58 mm)	0.04" (0.90 mm)	0.43" (11 mm)	SST	6-pk
ISM583	0.03" (0.84 mm)	0.05" (1.27 mm)	0.43" (11 mm)	SST	6-pk
ISM584	0.03" (0.84 mm)	0.05" (1.27 mm)	0.63" (16.0 mm)	SST	6-pk
ISM585A	0.01" (0.30 mm)	0.02" (0.63 mm)	0.98" (25 mm)	SST	6-pk
ISM586A	0.02" (0.58 mm)	0.04" (0.90 mm)	0.98" (25 mm)	SST	6-pk
ISM587	0.02" (0.58 mm)	0.04" (0.90 mm)	0.75" (19.0 mm)	SST	6-pk

## Peristaltic Tubing Adapters

These unique adapters connect peristaltic tubing to standard 1/16" or 1/8" OD tubing. A specially-designed nose allows the peristaltic tubing to simply press fit over the nose and then be held tightly in place by the retainer sleeve. Your 1/16" OD tubing may then be connected with the Flangeless Fittings supplied with the adapter. To connect your peristaltic tubing to tubing with a different OD, simply replace the supplied fittings with your choice of Flangeless Fittings from page 24.

One popular application for these adapters is to use them as "stops" for your peristaltic pump. By doing so, you can reduce the amount of peristaltic tubing required for your flow path, thus reducing cost.

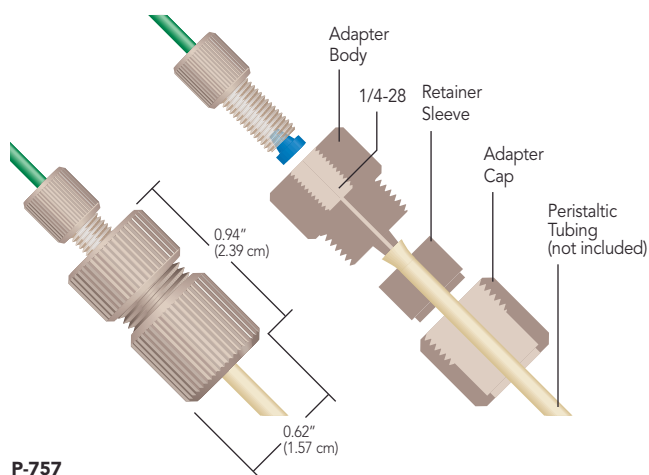

**P-757**  
Peristaltic Tubing Adapter  
includes P-200/P-235 Flangeless Fittings,  
and 3 sizes of retainer sleeves

## Conical Adapters

- ▶ Direct connect 1/16" and 1/8" OD rigid and semi-rigid tubing to peristaltic tubing
- ▶ Accept 0.020"–1/8" (0.50–3.2 mm) ID peristaltic tubing
- ▶ Biocompatible flow path with excellent chemical compatibility

Upchurch Scientific® Conical Adapters manufactured by IDEX Health & Science provide a reliable connection between rigid/semi-rigid tubing and peristaltic-type flexible tubing, such as Tygon® and PharMed®. These adapters are composed of a PEEK polymer female nut, our Super Flangeless™ ferrule system and an ETFE or PEEK conical adapter body. The narrow coned end of the adapter body allows peristaltic tubing to slide on more easily than it does onto conventional barbed adapters. Peristaltic tubing is also easier to remove from our Conical Adapters, since no cutting or excessive pulling is required.

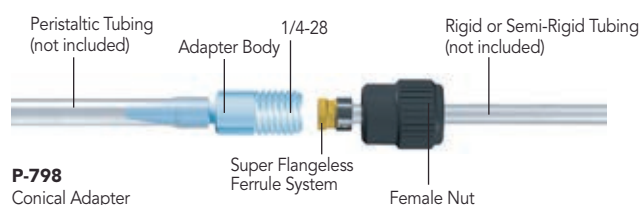
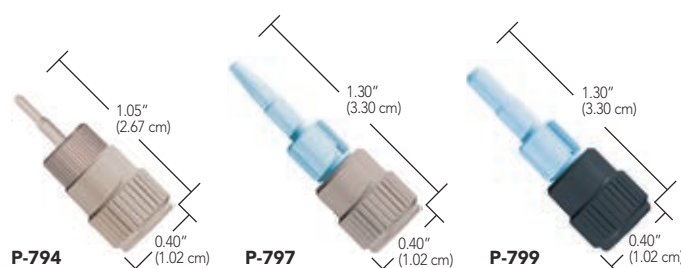

**P-798**  
Conical Adapter



## RELATED PRODUCTS

- ▶ Use the adapters on this page to connect rigid and semi-rigid tubing (pages 63–69 and 70–73) to the peristaltic tubing on pages 75–89.

## APPLICATION NOTE

To help secure peristaltic tubing more firmly to the Upchurch Scientific Conical Adapters, simply attach a cable tie to the outside of the peristaltic tubing once it has been placed onto the Adapter body.

Part No.	Description	Peristaltic Tubing OD	Peristaltic Tubing ID	Thru-Hole
<b>PERISTALTIC TUBING ADAPTERS</b>				
★ P-757	Standard Adapter	up to 0.180" (4.55 mm)	0.048"–0.110" (1.20–2.80 mm)	0.030" (0.75 mm)
P-767	Large Bore Adapter	up to 0.250" (6.35 mm)	0.100"–0.150" (2.55–3.80 mm)	0.070" (1.78 mm)
<b>CONICAL ADAPTER ASSEMBLIES</b>				
Part No.	Description	Rigid or Semi-Rigid Tubing OD	Peristaltic Tubing ID	Thru-Hole
★ P-794	Conical Adapter	1/16"	0.020"–0.030" (0.50 mm–0.75 mm)	0.020" (0.50 mm)
P-797	Conical Adapter	1/16"	1/16"–3/32" (1.55 mm–2.40 mm)	0.040" (1.0 mm)
P-798	Conical Adapter	1/8"	1/16"–3/32" (1.55 mm–2.40 mm)	0.040" (1.0 mm)
P-799	Conical Adapter	1/8"	3/32"–1/8" (2.40 mm–3.20 mm)	0.060" (1.5 mm)
<b>CONICAL ADAPTER REPLACEMENT PARTS</b>				
Part No.	Description	Material	For Use With	
F-156	Female Nut, 1/8", 1/4-28	Black PEEK	P-798, P-799	
P-420	Female Nut, 1/16", 1/4-28	Natural PEEK	P-794, P-797	
P-259	Super Flangeless Ferrule, 1/16"	Yellow ETFE/SST	P-794, P-797	
P-359	Super Flangeless Ferrule, 1/8"	Yellow ETFE/SST	P-798, P-799	
P-691	Conical Adapter Body	Natural ETFE	P-799	
P-692	Conical Adapter Body	Natural PEEK	P-794	